



Operating and Installation Instructions Oven



To prevent accidents and machine damage, read these instructions **before** installation or use.

Contents

IMPORTANT SAFETY INSTRUCTIONS	6
Guide to the oven	15
Control panel	16
Sensor buttons	17
Display	18
Symbols.....	19
Features	20
Model numbers	20
Data plate	20
Items included	20
Standard and optional accessories.....	20
Shelf runners	21
Baking tray, Roasting pan and Wire oven rack	21
FlexiClip telescopic runners HFC 71	22
Oven controls	26
Oven safety features	26
System lock 	26
Safety shut-off.....	26
Cooling fan	26
Vented oven door	26
PerfectClean surfaces	27
Catalytic enameled surfaces	27
Before first use	28
Standard settings	28
Heating the oven	30
Settings	31
Accessing the “Settings” menu.....	31
Changing and saving settings	31
Settings overview	32
Language 	34
Time of day.....	34
Display.....	34
Clock format.....	34
Setting the time	34
Date	34
Lighting.....	35
Display brightness.....	35
Audible tone information	35
Melody.....	35

Solo tone	35
Keypad tone	36
Units of measurement	36
Weight	36
Temperature	36
Cooling fan	37
Recommended temperatures.....	37
Safety	38
System lock 	38
Sensor lock	38
Calibrate temperature.....	39
Voltage.....	39
Showroom program.....	39
Demo Mode.....	39
Factory default.....	40
Timer	41
Setting the timer	41
Resetting the timer	42
Canceling the timer	42
Guide to the modes	43
Operating the oven	45
Energy saving tips	45
Quick Guide.....	46
Cooling fan	46
Additional functions	47
Changing the oven mode	47
Changing the temperature.....	48
Rapid PreHeat	48
Setting additional durations	49
Turning off automatically	50
Turning on and off automatically	50
Sequence of a cooking program that turns on and off automatically	51
Changing the set time	51
Canceling cooking.....	51
MasterChef	52
List of food types.....	52
Using the MasterChef programs	52
Notes on using these programs	53

Contents

Favorites	54
Creating a Favorite	54
Starting a Favorite	56
Changing Favorites.....	57
Changing cooking stages.....	57
Changing the name	57
Deleting a Favorite.....	57
Bake	58
Roast	60
Roast Probe.....	61
How the roast probe works	61
When to use the roast probe	61
Important notes regarding the roast probe	62
Using the roast probe.....	62
Time-left display	63
Using residual heat.....	64
Slow Roasting	65
Using the Slow Roasting function	66
Adjusting the Slow Roasting temperature	67
Broil	68
Special Modes	70
Defrost	71
Dehydrate	71
Reheat	72
Warm-up Cookware	73
Proof	73
Pizza	74
Sabbath Program	74
Gentle Bake.....	75
Canning	76
Frozen food.....	77
Cleaning and care	78
Unsuitable cleaning agents	78
Tips.....	79
Normal soiling.....	79
Cleaning the seal.....	79
Roast Probe.....	79
Stubborn soiling (excluding the FlexiClip runners).....	80

Contents

Stubborn soiling on the FlexiClip runners	81
Cleaning the catalytic enameled back panel.....	81
Removing soiling caused by spices, sugar and similar deposits.....	81
Removing oil and grease.....	82
Door removal.....	83
Reinstalling the door	84
Removing the shelf runners with FlexiClip telescopic runners.....	85
Removing the back panel.....	85
Lowering the Browning/Broiling element	86
Frequently Asked Questions	87
Technical Service.....	91
Contact in case of fault	91
Warranty	91
Caring for the environment	92
Electrical connection	93
Installation diagrams.....	94
Appliance and cut-out dimensions	94
Undercounter installation	94
Installation into a tall cabinet.....	95
Front dimensions	96
Installing the oven	97

IMPORTANT SAFETY INSTRUCTIONS

When using the appliance, follow basic safety precautions, including the following:

Read all instructions before installation and use of the oven to prevent accidents and machine damage.

This appliance complies with current safety requirements. Improper use of the appliance can lead to personal injury and material damage.

Read all instructions before installing or using the oven for the first time. Only use the appliance for its intended purpose.

Keep these operating instructions in a safe place and pass them on to any future user.

Appropriate use

- ▶ This appliance is intended for residential use only. Use only as described in these operating instructions.
- ▶ This appliance is not intended for outdoor use.
- ▶ Only use this oven for residential cooking, and the purposes described in this manual. Other uses are not permitted and can be dangerous.
- ▶ Risk of Fire! Do not use this oven to store or dry flammable materials.
- ▶ Persons who lack physical, sensory or mental abilities, or experience with the appliance should not use it without supervision or instruction by a responsible person.

IMPORTANT SAFETY INSTRUCTIONS

Safety with children

- ▶ Children should not be left alone or unattended in an area where an oven is in use. Never allow children to operate, sit or stand on any part of the oven. **Caution:** Do not store items of interest to children in cabinets above an oven. Children climbing on the oven to reach these items could be injured.
- ▶ Burn Hazard - Do not allow children to use the oven. Failure to do so can result in severe burns or serious injury.
- ▶ Danger of suffocation! Ensure that any plastic wrappings, bags, etc. are disposed of safely and kept out of the reach of children.
- ▶ Danger of burns. The oven gets hot at the oven door glass, the vapor vent, the handle and the operating controls. Do not allow children to touch or play in, on or near the oven.

Technical safety

- ▶ This appliance must be installed and connected in compliance with the installation instructions.
- ▶ Unauthorized installation, maintenance, and repairs can cause considerable danger for the user. Installation, maintenance, and repairs must only be carried out by a Miele authorized technician.
- ▶ Maintenance by the user: Never repair or replace any part of the appliance unless the instructions specifically recommend doing so. Service work should only be performed by a qualified technician.
- ▶ Before installing the oven, check for externally visible damage. Do not operate a damaged appliance.
- ▶ Reliable and safe operation of the oven can only be guaranteed if it is connected to the power supply.

IMPORTANT SAFETY INSTRUCTIONS

- ▶ To guarantee the electrical safety of this appliance, continuity must exist between the appliance and an effective grounding system. This appliance must be grounded. Connect only to properly grounded outlet. See “Electrical connection - GROUNDING INSTRUCTIONS”. It is imperative that this basic safety requirement be met. If there is any doubt, have the electrical system of the house checked by a qualified electrician.
- ▶ Proper installation: Make sure that your appliance has been installed correctly and that it has been grounded by a qualified technician.
- ▶ Before installation, make sure that the voltage and frequency listed on the data plate correspond with the household electrical supply. This data must correspond to prevent injury and machine damage. Consult a qualified electrician if in doubt.
- ▶ Before installation or service, disconnect the power supply to the work area by
 - removing the fuse,
 - “tripping” the circuit breaker, or
 - unplugging the unit. Pull the plug not the cord.
- ▶ Extension cords do not guarantee the required safety of the appliance (e.g. danger of overheating). Do not use an extension cord to connect this appliance to electricity.
- ▶ The oven is not to be operated until it has been properly installed within cabinetry.
- ▶ Danger of electric shock!
Under no circumstances open the outer casing of the appliance.
- ▶ This appliance must not be used in a non-stationary location (e.g. on a ship).

IMPORTANT SAFETY INSTRUCTIONS

- ▶ Do not repair or replace any part of the appliance unless specifically recommended in the operating instructions. All other servicing should be referred to a qualified technician.
- ▶ Defective components should be replaced by Miele original parts only. Only with these parts can safety of the appliance be assured as intended by the manufacturer.
- ▶ In order for the oven to function correctly, it requires an adequate supply of cool air. Ensure that the air flow is not impaired (e.g. insulation in the cabinetry). Also be sure that the cool air supply is not heated by other sources nearby.
- ▶ If the oven is installed behind a cabinet door, do not close the door while the oven is in operation. Heat and moisture can build up behind the closed door and cause damage to the oven, cabinetry and flooring. Do not close the door until the oven has completely cooled down.

Correct use

 The oven becomes very hot while in use. Use caution to ensure that you are not burned on the heating elements or interior surfaces of the oven. Use pot holders when placing food in the oven, adjusting the racks, etc. in a hot oven.

- ▶ Caution: Heating elements may be hot even though they are not glowing. Interior surfaces of an oven become hot enough to cause burns. External parts of the oven such as the door glass, vents, and the control panel can become hot. During and after use, do not touch, or let clothing or other flammable materials come into contact with heating elements or interior surfaces of the oven until they have had sufficient time to cool.
- ▶ Do not let food sit in the oven for an extended period of time before or after cooking. Doing so can result in food poisoning or sickness.

IMPORTANT SAFETY INSTRUCTIONS

- ▶ It is important that the heat is evenly distributed throughout the food being cooked. This can be achieved by stirring and/or turning the food.
- ▶ Use only dry, heat-resistant potholders. Moist or damp potholders used on hot surfaces may result in steam burns. Do not let potholders come in contact with oil or grease. Do not substitute dish towels or other bulky items for potholders. Do not let potholders touch hot heating elements.
- ▶ Loose fitting or hanging garments present a fire hazard. Wear proper apparel while operating the appliance.
- ▶ Do not heat unopened containers of food in the oven, pressure may cause the containers to burst and result in injury.
- ▶ Never pour cold water onto hot surfaces in a hot oven. The steam created could cause serious burns or scalding and the sudden change in temperature can damage the enamel in the oven.
- ▶ To prevent burns, always place oven racks at their desired height while the oven is cool. If the rack must be moved while the oven is hot, do not let pot holders touch hot heating elements.
- ▶ Open the door carefully to allow hot air or steam to escape before placing or removing food.
- ▶ To prevent burns, allow the heating elements to cool before cleaning by hand.
- ▶ Do not leave the oven door open unnecessarily as someone may trip over it or be injured by it.
- ▶ Never leave the appliance unattended when cooking with oil or fat. They can ignite if overheated. Do not use water on grease fires. Turn off the oven immediately and smother the flames by keeping the oven door closed.
- ▶ Smother the fire or flames, or use a dry chemical extinguishing agent or foam fire extinguisher.

IMPORTANT SAFETY INSTRUCTIONS

- ▶ Never store flammable liquids and materials in, above or under an oven, or near cooking surfaces.
- ▶ Do not use the oven to heat the room. The high temperatures radiated could cause objects near the oven to catch fire.

WARNING



NEVER use this appliance as a space heater to heat or warm the room. Doing so may result in carbon monoxide poisoning and overheating of the oven.

WARNING

NEVER use this appliance as storage space. Doing so may result in carbon monoxide poisoning and overheating of the oven.

WARNING

NEVER cover any slots, holes or passages in the oven bottom or cover an entire rack with materials such as aluminum foil. Doing so blocks air flow through the oven and may cause carbon monoxide poisoning. Aluminum foil linings may also trap heat, causing a fire hazard.

- ▶ Broiling food for an excessively long time can cause it to dry out and may result in the food catching fire.
Do not exceed recommended broiling times.
- ▶ Some foods dry out very quickly and can be ignited by high broiling temperatures. Do not use broiling modes for crisping rolls or bread, or to dry flowers or herbs. Instead use the Convection Bake  or Surround  modes.
- ▶ Use caution when using alcohol in your recipes. Alcohol evaporates at high temperatures but may, in rare circumstances, combust on the hot heating elements.

IMPORTANT SAFETY INSTRUCTIONS

- ▶ Plastic containers, which are not heat-resistant, melt and may ignite at high temperatures and can damage the oven. Use only plastic containers that are indicated by the manufacturer as being suitable for use in ovens.
- ▶ When residual heat is used to keep food warm, the high level of humidity and condensation can cause damage in the oven. The control panel, countertop or cabinetry may also be damaged. Do not switch the oven off completely while food is inside it, but select the lowest possible temperature for the oven mode you are using. This will ensure the fan will automatically continue to run.
- ▶ It is recommended to cover all cooked food that is left in the oven to be kept warm. This will prevent moisture from condensing on the interior of the oven.
- ▶ To avoid damage, do not place aluminum foil, pots, pans or baking sheets directly on the oven floor. This can cause a build up of heat that will damage the oven floor.
- ▶ Do not slide pots or pans on the oven floor. This could scratch and damage the surface.
- ▶ The door can support a maximum weight of 33 lbs (15 kg). Do not sit on or lean against an open door, and do not place heavy objects on it. Also make sure that nothing can get trapped between the door and the oven cavity. The oven could get damaged.
- ▶ This oven must only be used for cooking food. Fumes, vapors or heat given off by glues, plastics or flammable liquids and materials could be hazardous. Do not use it as a dryer, kiln, dehumidifier, etc.
- ▶ Do not obstruct the flow of combustion and ventilation air.
- ▶ Do not let metal objects (aluminum foil, pans) come in contact with the heating element.
- ▶ Make certain that the power cords of small appliances do not come in contact with or get caught in the oven door.

IMPORTANT SAFETY INSTRUCTIONS

▶ When baking frozen pizzas or pies, place them on the wire rack lined with parchment paper. Do not use the baking tray or the roasting pan for frozen foods with a large surface area. The tray or pan could become warped and difficult to remove from the oven when hot. Frozen foods like french fries, chicken nuggets, etc. can be baked on the baking tray.

Cleaning and maintenance

▶ Do not use a steam cleaner to clean this oven.

Steam could penetrate electrical components and cause a short circuit.

▶ Only clean parts listed in these Operating and Installation Instructions.

▶ Scratches on the door glass can cause the glass to break. Do not use abrasive cleaners, hard sponges, brushes or sharp metal tools to clean the door glass.

▶ The shelf runners can be removed for cleaning purposes (see “Cleaning and care”). Ensure they are correctly fitted after cleaning and never operate the oven without the shelf runners inserted.

▶ The back panel can be removed for cleaning purposes (see “Cleaning and care”). Ensure it is correctly fitted after cleaning and never operate the oven without the back panel fitted.

▶ There is a seal around the oven interior which seals the inside of the door. Take care not to rub, damage or move the gasket. Do not clean the door gasket - the door gasket is essential for a good seal.

▶ Do not use a protective coating to line the oven and do not use commercial oven cleaner unless certified for use in a self-cleaning oven.

IMPORTANT SAFETY INSTRUCTIONS

Accessories

▶ Use only genuine original Miele parts. If parts or accessories from other manufacturers are used, the warranty will become void.

▶ If you have a Miele Gourmet Casserole Dish HUB 5000-M/HUB 5001-M/ HUB 5000-XL do not place it on shelf level 1. This can damage the oven floor. The small gap between the bottom of the dish and the oven floor would cause a build-up of heat and could cause the enamel to crack or chip.

Do not place Miele Casserole Dishes on the top rail of shelf level 1, they will not be secure in this position by the anti-tip safety notches on the sides of the dish.

Use self level 2 for these dishes.

▶ Only use the Miele roast probe supplied with this oven. If it is faulty, it must only be replaced with a Miele genuine roast probe.

▶ The plastic on the roast probe can melt at very high temperatures. Do not use the roast probe when using the broil functions (exception: Convection Broil ). Do not store the roast probe in the oven if it is not in use.

SAVE THESE INSTRUCTIONS AND REVIEW THEM PERIODICALLY

Guide to the oven

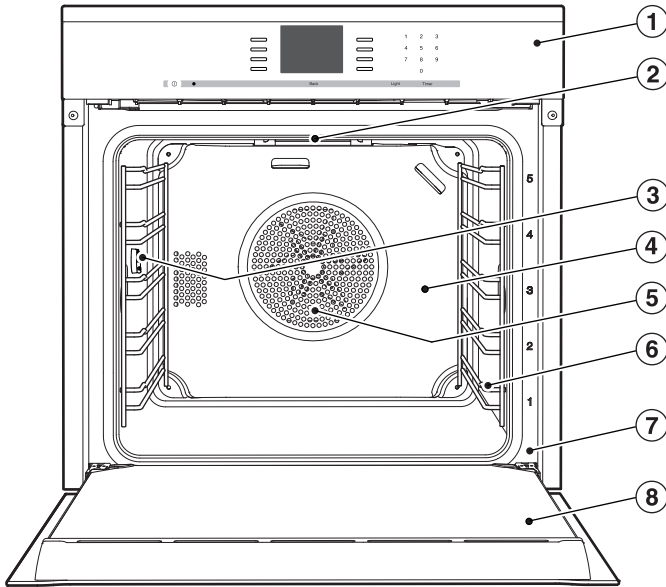

- ① Oven controls
- ② Browning / Broiling element
- ③ Connection socket for the roast probe
- ④ Catalytic enameled back panel
- ⑤ Convection fan with heating element
- ⑥ Runners with 5 shelf levels
- ⑦ Front frame with data plate
- ⑧ CleanGlass Door

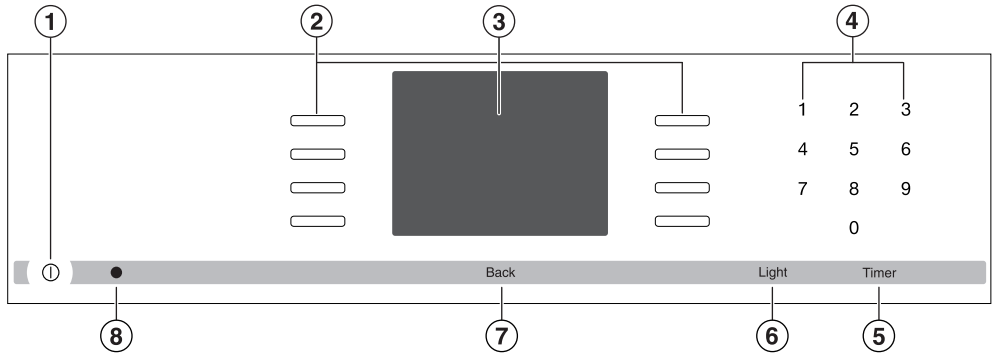

Control panel



- ① On / Off ① button
Turns the oven On and Off
- ② Sensor buttons 
To select operating modes, settings and menu items
- ③ Display
Displays the time of day and information on the operation
- ④ Sensor buttons 0-9
Numeric keypad to enter values
- ⑤ “Timer” sensor button
To set the timer
- ⑥ “Light” sensor button
For turning the oven interior lighting on and off
- ⑦ “Back” sensor button
To go back one step at a time
- ⑧ Optical interface
(for service technician use only)

Sensor buttons

The sensors react to touch. Each touch is confirmed with an audible tone. This tone can be turned off (see “Settings – Keypad tone”).

Sensor button	Function	Notes
	For selecting options and scrolling through the list of options	A menu option can be selected by touching the illuminated sensor  next to it.
0–9	Numerical keypad for setting values	The numerical keypad is used to set values, e.g. temperatures and durations.
Timer	To set the timer	If a list of options is showing in the display or if a cooking process is running, a timer duration (e.g., when boiling eggs) can be set at any point. If the time of day display is turned off, the “Timer” button will not react until the oven is turned on.
Light	For turning the oven interior lighting on and off	If a list of options is showing in the display or if a cooking process is running, touching “Light” will turn the oven interior lighting on or off. If the time of day display is turned off, the “Light” sensor button will not react until the oven is turned on. The oven interior lighting turns off after 15 seconds during cooking or remains constantly turned on, depending on the setting selected.
Back	To go back a step	

Control panel



Display

The display is used for showing the time of day or information about modes, temperatures, cooking durations, MasterChef programs and settings. Information or a list of options is shown on the display depending on the function selected.

After turning the oven on with the On/Off sensor button ①, the main menu will appear:









If a cooking process is running, selecting **Change** will call up a list of options which can be set or changed for the cooking process in progress.

- Temperature
- Core Temperature (only when using the roast probe)
- Duration
- Ready at
- Start at (only if Duration / Ready at has been set)
- PreHeating (only available in some operating modes)
- Operating Modes

- A menu item can be selected by touching the illuminated sensor  next to the menu item.
- Options can then be accessed by touching the illuminated sensor  next to OK.

Symbols

The following symbols may appear in the display:

Symbol	Description
	Timer
-	Allocates an illuminated Sensor button  to an option and indicates that the option can be selected.
	If more than four options are available a bar will appear on the right-hand side of the display. Use the allocated sensors to scroll through the list.
.....	The end of a list is indicated by a dotted line. By scrolling down further, you will reach the beginning of the list again.
	Some settings, e.g. display brightness and buzzer volume, are selected using a bar chart.
✓	A check indicates the currently active setting. - will not be displayed and the corresponding sensor will not be illuminated.
	This symbol indicates that there is additional information and advice about using the oven. Select <i>OK</i> to access the information.
	The system lock or sensor lock is active (see “Settings – Safety”). The oven cannot be used.
	Program finished
	Core temperature when using the roast probe

Features

Model numbers

A list of the ovens described in these operating instructions can be found on the back page.

Data plate

The data plate located on the front frame of the oven is visible when the door is open.

Printed on the data plate are the model number, serial number and the connection data (voltage/frequency/maximum rated load) of the oven.

Have this information available when contacting Miele Technical Service.

Items included

The following items are included with this appliance:

- the Operating and Installation Instructions,
- screws for securing your appliance into the cabinetry, and
- various accessories.

Standard and optional accessories

Accessories vary depending on model. **All ovens are supplied with shelf runners, a universal tray and a wire oven rack.** Depending on the model, your oven may also come with the additional accessories listed.

All accessories and cleaning and care products in these instructions are designed to be used with Miele ovens.

These can be ordered from the Miele web store, Miele Technical Service, or from your Miele dealer.

When ordering, please have ready the model number of your oven and of the desired accessories.

Shelf runners

Side runners are located on the right and left-hand sides of the oven with 5 levels for inserting accessories.

The shelf level numbers are indicated on the front of the oven frame.

Each side runner consists of two rails:

- The accessories (e.g. wire oven rack) slide in between the rails.
- The FlexiClip telescopic runners (depending on model) are inserted on the bottom rail.

The runners can be removed for cleanings purposes. See “Cleaning and Care”.

Baking tray, Roasting pan and Wire oven rack

Baking tray HBB 71

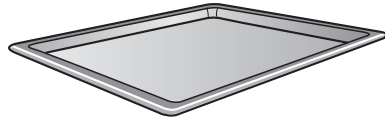

Roasting pan HUBB 71

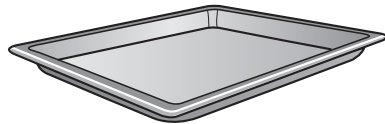

Wire oven rack HBBR 71

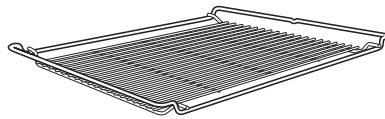

These accessories are inserted into the oven between the two rails of a side runner.

Always position the wire rack as illustrated above.

Non-tip safety notches are located on the shorter sides of these accessories. These prevent the trays being pulled completely out of the side runners when you only wish to pull them out partially.



If you are using the roasting pan with the wire rack, insert the roasting pan between the rails of the side runners and the rack will slide in above it.

Features

FlexiClip telescopic runners HFC 71

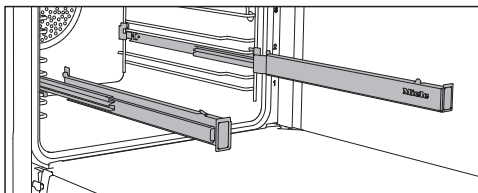

The FlexiClip telescopic runners can be attached to any shelf level.

Push the FlexiClip telescopic runners all the way into the oven before placing accessories on them.

The accessories will then automatically sit securely in between the stoppers at either end of each runner and be prevented from sliding off.

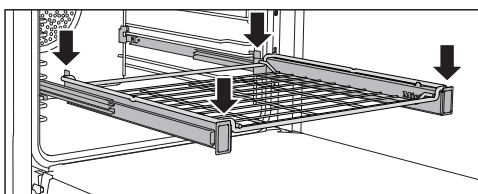
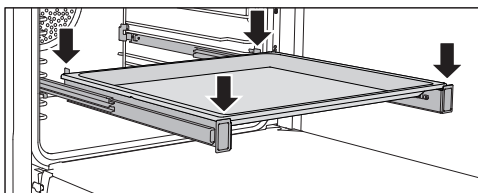

The FlexiClip runners can support a maximum load of 33 lbs (15 kg).

Installing and removing the FlexiClip telescopic runners

 Danger of burns! Make sure the heating elements are turned off and that the oven cavity is cool.

The FlexiClip telescopic runners are inserted in between the two rails that make up a shelf level.

The telescopic runner with the Miele logo must be inserted on the right.

When inserting or removing the telescopic runners, do **not** extend them.

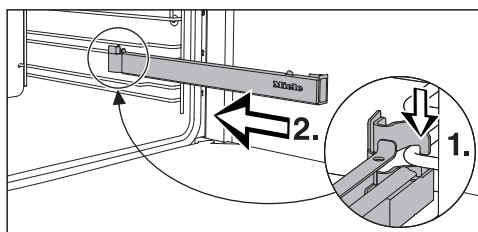

- Hook the FlexiClip runner onto the front of the lower rail of a side runner (1.) and then push it along the rail into the oven compartment (2.).

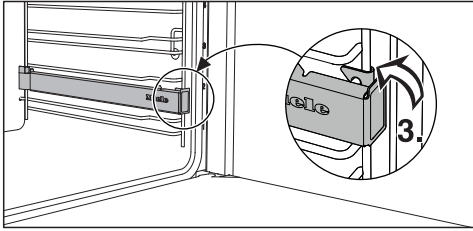

- Then secure the FlexiClip runner to the bottom of the two rails as illustrated (3).

If the telescopic runners are difficult to pull out after inserting, you may need to pull firmly to release them.

To remove a FlexiClip telescopic runner:

- Push the FlexiClip runner in all the way.

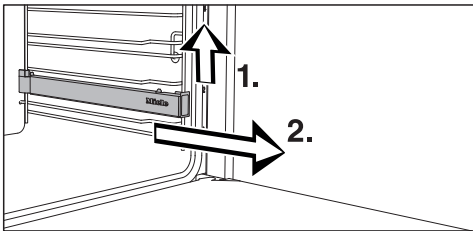

- Remove the FlexiClip telescopic runner by raising it at the front (1) then pulling it forwards along the rail and out (2).

Perforated Gourmet baking tray HBBL 71

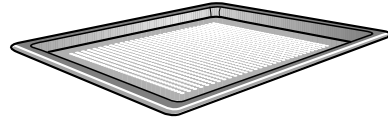

The perforated Gourmet baking tray has been specially developed for the preparation of baked goods made from fresh yeast and quark doughs. The tiny perforations assist in browning the underside of baked goods. The tray can also be used for dehydrating or drying food.

The enameled surface has been treated with PerfectClean.

The **round perforated baking tray HBFP 27-1** can be used for the same things.

Grilling and Roasting insert HGBB 71

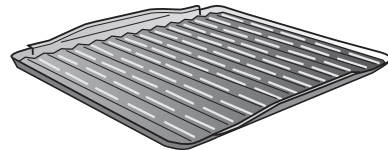

The grilling and roasting insert is placed in the universal tray.

The drippings from the meat or poultry are collected under the insert reducing spattering in the oven. The drippings can then be used for gravy and sauces.

The surface has been treated with PerfectClean enamel.

Features

Round baking form HBF 27-1



This circular form is suitable for cooking fresh or frozen pizzas, flat cakes, tarts and baked goods.

The surface has been treated with PerfectClean enamel.

Gourmet Baking Stone HBS 60

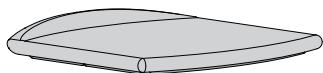

The baking stone is ideal for baking dishes with a crisp bottom such as pizza and bread.

The baking stone is made from a heat retaining stone and is glazed. Place the stone directly on the wire rack.

A wooden peel is supplied with it for placing food on and off the stone.

Gourmet Casserole Dishes HUB and Lids HBD

The Miele casserole dishes, unlike other oven dishes, slide into the oven on the side runners. They have non-tip safety notches to prevent them being pulled out too far.

They also have a non-stick coating.

The oven dishes have depths of 8 1/2" (22 cm) or 13 3/4" (35 cm). They have the same width and height.

Matching lids are also available separately.

**Depth: 8
1/2" (22 cm)**

HUB 5000-M

HUB 5001-M*



HBD 60-22

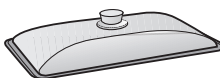

**Depth: 13
3/4" (35 cm)**

HUB 5000-XL

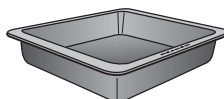

HBD 60-35

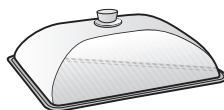

* Suitable for induction cooktops

Roast Probe

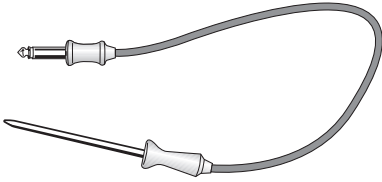

The roast probe reliably monitors the roasting process. The tip of the probe continuously measure the core temperature of the meat or poultry.

The FlexiClip runners cannot be fitted to Shelf level 4 when using the roast probe, as they would cover the connection socket for the roast probe.

Opener

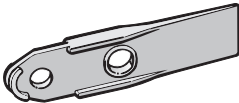

The opener allows you to open the cover of the oven light.

Catalytic enameled liners

- Side walls
These are installed behind the shelf runners and protect the interior walls against soiling.
- Ceiling panel
This is installed above the Browning / Broiling element to protect the ceiling against soiling.
- Back wall
The back wall should be replaced if the catalytic enamel has become ineffective due to incorrect use or heavy soiling.

When ordering, please quote the model number of your oven.

Miele Oven Cleaner

Miele oven cleaner is suitable for removing stubborn soiling. It is not necessary to preheat the oven before use.

Features

Oven controls

The oven controls allow you to use the various cooking modes to bake, roast and broil.

It also allows you to access:

- the time of day display,
- a timer,
- a timer to automatically turn cooking programs on and off,
- the MasterChef programs,
- the creating of a Favorite program,
- settings that can be customized.

Oven safety features

System lock

The system lock prevents the oven from being used unintentionally (see “Settings - System lock”).

The system lock will remain activated even after a power failure.

Safety shut-off

The oven automatically turns itself off if it is used for an exceedingly long period. The length of time depends on the oven mode being used.

Cooling fan

The cooling fan comes on automatically when a cooking program is started. The cooling fan mixes hot air from the oven cavity with cool room air before venting it out into the kitchen through vents located between the appliance door and the control panel.

The cooling fan will continue to run for a while after a program is complete to prevent moisture from building up in the oven, on the control panel or surrounding cabinetry.

When the temperature in the oven has fallen sufficiently, the cooling fan will turn off automatically.

Vented oven door

The oven door is made of glass panes that have a heat-reflective coating on part of their surface.

During operation, air is also circulated through the door to keep the outer panel cool.

The door can be removed and disassembled for cleaning purposes (see “Cleaning and care”).

PerfectClean surfaces

The revolutionary PerfectClean finish is a smooth, non-stick surface that is exceptionally easy to clean.

Food and grime from baking or roasting are easily removed.

Do not use ceramic knives, as these will scratch the PerfectClean surface.

Follow the instructions in the “Cleaning and Care” section of this manual so the anti-stick and easy cleaning properties are retained.

The following have all been treated with PerfectClean:

- Oven interior
- Shelf runners
- FlexiClip telescopic runners
- Universal tray
- Baking tray
- Wire oven rack
- Grilling and Roasting insert
- Perforated baking tray
- Round baking form

Catalytic enameled surfaces

The back panel is coated with catalytic enamel. Soiling from oil and fat is burnt off this type of surface when very high temperatures are used in the oven.

See “Cleaning and care” for more information.

Before first use

Standard settings

 The oven must not be operated until it has been properly installed within cabinetry.

The oven will turn on automatically when it is connected to the power supply.

Welcome screen

A welcome greeting is displayed. You will then be asked to select some basic settings which are needed before the appliance can be used.

- Follow the instructions on the display.

Set the language

- Scroll through the list until the desired language appears.
- Touch the illuminated sensor next to the language you want to select.
- Confirm with OK.

Select the country

- Scroll through the list until the desired country appears.
- Touch the illuminated sensor next to the country you want to select.
- Confirm with OK.

Setting the voltage (electrical version)

 The voltage set must match that of the house as to not damage the oven.

Confirm the voltage before setting. If in doubt contact a qualified technician.

- Select the voltage.
- Confirm with OK.

Set the date

- Use + or – to set the year, month and day.
- Confirm with OK.

Set the time of day

- Use the numerical keypad to set the time of day in hours and minutes (e.g. 1-2-1-5 for 12:15).
- Confirm with OK.
- Select the lit sensor button next to am or pm.
- Confirm with OK.

The time of day can be displayed in 24-hour format (see “Settings - Time of Day - Clock Format”).

Time of day display

You will then be asked when you want the time of day to show in the display when the oven is turned off (see “Settings - Time of day - Display”):

– On

The time is always visible in the display.

– Off

The display appears dark to save energy. Some modes are limited.

– Night Dimming

The time only shows in the display between 5:00 am and 11:00 pm. It turns off at night to save energy.

■ Select the desired option.

■ Confirm with OK.

Information regarding energy consumption will appear in the display.

■ Confirm with OK.

Set up Successfully Completed is displayed.

■ Confirm with OK.

The oven is now ready to use.

If you accidentally select the wrong language, follow the instructions described in “Settings - Language ”.

Before first use

Heating the oven

New ovens may have a slight odor during their first use. Heating up the oven for at least one hour with nothing in it will eliminate the odor.

Ensure that the kitchen is well ventilated while the appliance is being heated up for the first time. Close doors to other rooms to prevent the smell spreading throughout the house.

- Remove any protective wrapping and sticky labels from the oven.
- Take all accessories out of the oven and clean them (see “Cleaning and care”).
- Before heating the oven up, wipe the interior with a damp cloth to remove any dust or bits of packaging that may have accumulated in the oven cavity during storage and unpacking.
- Turn on the oven.

The main menu will appear.

- Select Operating Modes.
- Select Convection Bake 

The default temperature is displayed 350°F (160°C).

The oven heating, lighting and cooling fan will turn on.

- Set the maximum temperature.
- Confirm with OK.

Heat up the oven for at least one hour.

After at least an hour:

- Turn the oven off.

After heating up for the first time

 Danger of burns! Allow the oven to cool before cleaning.

- Turn on the oven.
- Select Light to turn on the oven light.
- Take all accessories out of the oven and clean them by hand (see “Cleaning and care”).
- Clean the oven interior with warm water and liquid dish soap, applied with a soft sponge or cloth.
- Dry all surfaces with a soft cloth.
- Turn the lighting and the oven off.

Leave the oven door open until the oven interior is completely dry.

Accessing the “Settings” menu

- Select Settings .

A list of settings will appear in the display.

They can be checked and changed, if needed.

A check  next to an option shows which setting is active.





Settings cannot be altered while a cooking program is in progress.

Changing and saving settings

- Select Settings .
- Scroll through the list until the desired setting appears.
- Touch the sensor button next to the setting. The desired setting may appear in a submenu.
- Change the setting.
- Confirm with OK.
- Touch “Back” until the main menu appears or select another setting.

Settings

Settings overview

Option	Available settings
Language 	... / deutsch / english / ... Country
Time	Show On / Off * / Night Dimming Clock Format 24 h / 12 h * Set
Date	
Lighting	On / On for 15 Seconds *
Display Brightness	
Audible tone information	Melody  Solo Tone 
Keypad Tone	
Units of Measurement	Weight g / lb / lb:oz * Temperature °C / °F *

* Factory default

Option	Available settings
Cooling Fan	Temp. Controlled * Time Controlled
Default Temperature	
Safety	System Lock  On / Off * Sensor Lock On / Off *
Calibrate Temperature	■■■■■▶■■■■
Voltage	208V / 60Hz 220V / 60Hz 240V / 60Hz
Showroom Program	Demo Mode On / Off *
Factory Default	Settings Favorites Default Temperature

* Factory default

Settings

Language

The desired country and language can be set.

After selecting and confirming your choice, the language selected will appear in the display.

Tip: If you accidentally select a language you do not understand, select the  symbol to return to the submenu.

Time of day

Display

Select how you would like the time of day to appear in the display when the oven is turned off:

- On

The time of day will always appear in the display. To turn the lighting “Light” on and off or use the “Timer” touch the relevant sensor.

- Off

The display is turned off to save energy. The oven has to be turned on before you can use it. This also applies when using the timer and the oven light.

- Night Dimming

To save energy, the time is only visible in the display between 5:00 am and 11:00 pm. The rest of the time it is not visible.

Clock format

You can select the clock format for the time of day:

- 24 h

The time of day is shown in a 24 hour clock format.

- 12 h

The time of day is shown in a 12 hour clock format.

Setting the time

Set the hours and the minutes.

If there is a power failure, the current time of day will reappear once the power has been restored. The time is stored in memory for about 200 hours.

Date

Set the date.

Lighting

- On

The interior lighting is turned on during the entire cooking period.

- On for 15 Seconds

The oven lighting turns off 15 seconds after a program starts. Touching "Light" turns it on for another 15 seconds.

Display brightness

The display brightness is represented by a bar with seven segments.



- Select **Darker** or **Brighter** to change the brightness of the display.

Audible tone information

Melody

At the end of a process, a melody will sound several times in intervals.

The volume of the melody is represented by a bar with seven segments.



Maximum volume is selected when all segments are filled. If none of the segments are filled, the volume is turned off.

- Select **Quieter** or **Louder**, to adjust the volume.
- Select **On** or **Off**, to turn the melody on or off.

Solo tone

At the end of a process, a continuous tone will sound for period of time.

The pitch of this tone is represented by a segment bar.

- Select **Lower** or **Higher**, to change the pitch.
- Select **On** or **Off**, to turn the tone on or off.

Settings

Keypad tone

An audible tone is heard with each touch of a sensor.

The volume of the keypad tone is represented by a bar with seven segments.



Maximum volume is selected when all segments are filled. If none of the segments are filled, the volume is turned off.

- Select **Quieter** or **Louder**, to adjust the volume.
- Select **On** or **Off**, to turn the keypad tone on or off.

Units of measurement

Weight

- g

The weight of food in MasterChef programs is shown in grams.

- lb

The weight of food in MasterChef programs is shown in pounds.

- lb:oz

The weight of food in MasterChef programs is shown in pounds and ounces.

Temperature

- °C

The temperature is displayed in Celsius.

- °F

The temperature is displayed in Fahrenheit.

Cooling fan

The cooling fan will continue to run for some time after the oven has been turned off to prevent humidity from building up in the oven, on the control panel or in the surrounding cabinetry.

- Temp. Controlled

The cooling fan will turn off when the oven compartment temperature drops below 160°F (70°C).

- Time Controlled

The cooling fan will turn off after approx. 25 minutes.

Condensation can cause the cabinetry and the countertop to be damaged. This could lead to corrosion of the appliance.

When keeping food warm in the oven, increases to the *Time Controlled* setting can lead to condensation of the control panel, moisture on the countertop and on the cabinetry.

Do not adjust the *Time Controlled* setting and try not to leave food in the warm oven.

Recommended temperatures

If you often cook with temperatures that differ from the default, it makes sense to change the recommended temperatures.

After selecting this option, a list of oven modes will appear in the display.

- Select the desired mode.

The recommended temperature is displayed along with the available temperature range.

- Change the recommended temperature.
- Confirm with *OK*.

Settings

Safety

System lock

The system lock prevents the oven being turned on inadvertently.

The system lock will remain activated even after a power failure.

Select **On** to activate the system lock.

The timer can still be used when the system lock is active.

– **On**

The system lock is now active. If you want to use the oven press and hold the sensor next to **OK** for at least 6 seconds.

– **Off**

The system lock is not active. The oven can be used as normal.

Sensor lock

The sensor lock prevents a cooking process from being switched off or changed while it is running. Once activated, the sensors are locked a few seconds after a program has started.

– **On**

The sensor lock is activated. Touch the sensor next to **OK** for at least 6 seconds to use the functions again. The sensor lock is then deactivated for a short period.

– **Off**

The sensor lock is not active. All sensors react to touch as normal.

Calibrate temperature

Using temperature calibration the temperature can be modified, in all modes and MasterChef programs, so that it is slightly higher or lower than shown.

The temperature calibration is represented by a bar with seven segments.



If all of the segments are filled the oven temperature is much higher than indicated in the display. If no segment is filled the oven temperature is much lower than indicated.

- Select + or -, to adjust the temperature calibration.
- Confirm with OK.

Voltage

Setting the voltage (electrical version)

- Select the desired voltage and corresponding frequency.
- Confirm with OK.

Showroom program

This function enables the oven to be demonstrated in showrooms without heating up. It should not be set for domestic use.

Demo Mode

If you have demo mode activated Demo mode active. The appliance will not heat up *will appear* when you turn on the oven.

- On
Press and hold OK for at least 4 seconds to activate demo mode.
- Off
Press and hold OK for at least 4 seconds to deactivate demo mode. The oven can then be used as normal.

Settings

Factory default

- Settings

Any settings that have been altered will be reset to the factory default setting.

- Favorites

All Favorites will be deleted.

- Default Temperature

Any default temperatures that have been changed will reset to the factory default settings.

The timer can be used to time any activity in the kitchen, e.g. boiling eggs.

The timer can also be used at the same time as a cooking program if a start and finish time have been set, e.g. a reminder to stir the dish or add seasoning.

A maximum timer duration of 9 hours, 59 minutes and 59 seconds can be set.

Setting the timer

When the setting **Time - Show - Off** is set the oven must be turned on to set the timer. The timer can then be seen counting down in the display when the oven is turned off.

Example: Boiling eggs and setting the timer for 6 minutes and 20 seconds.

- Select “Timer”.
- “0 : 00 : 00” (h : min : sec) will appear.
- Use the numerical keypad to enter a different duration (6-2-0).
- Confirm with OK.

The timer duration is now saved.

The duration counts down in the display when the oven is turned off.

If a cooking program is running at the same time, the timer duration will appear at the bottom of the display.

Timer

At the end of the timer

- 🔔 flashes,
 - the time starts counting upwards,
 - a buzzer will sound if turned on (see “Settings - Acoustic information”).
- Select the “Timer” button.

The buzzer will turn off and the symbols in the display will go out.

Resetting the timer

- Select “Timer” or the illuminated sensor next to the timer duration that is counting down.

The time previously set appears

- Set the new timer duration using the numeric keypad.
- Confirm with OK.

The changed time is saved and will count down in seconds.

Canceling the timer

- Select “Timer” or the illuminated sensor next to the timer duration that is counting down.

The time previously set appears







- Select `Reset`.

The timer has been canceled.









Guide to the modes

The oven has a wide range of modes for preparing a variety of foods.

Due to country-specific preferences for preparation of food, default temperatures and temperature ranges in °F and °C do not correspond. The temperature values have been defined as given in the chart.

Mode	Default temperature	Temperature range
Convection Bake  Use this mode for baking and roasting on several levels at the same time. You can cook at lower temperatures than with the Surround  mode because the fan distributes the heat evenly throughout the cavity for a consistent baking temperature.	350 °F (160 °C)	75–475 °F (30–250 °C)
Surround  This premium baking mode uses heat from the upper and lower elements to create perfect results on all baking recipes.	350 °F (180 °C)	75–525 °F (30–280 °C)
Intensive  This mode gently circulates heated air from the lower heating element using the fan to create a brick oven environment. Ideal for baking pizza, focaccia, pies and tarts that require a crisp base and moist toppings.	400 °F (170 °C)	125–475 °F (50–250 °C)
Auto Roast  For a premium result, the meat is seared at a high temperature keeping meat tender and juicy.	375 °F (160 °C)	200–450 °F (100–230 °C)
Convection Roast  This mode uses the convection fan to circulate heated air throughout the oven. Ideal for cooking delicate cuts of meat, fish and crispy poultry.	375 °F (160 °C)	75–475 °F (30–250 °C)

Guide to the modes

Mode	Default temperature	Temperature range
Bake  This mode uses traditional baking techniques to perfect pies and biscuits.	375 °F (190 °C)	200–525 °F (100–280 °C)
Browning  For a perfectly browned topping, for example when making a gratin or browning the top of a casserole.	350 °F (190 °C)	200–475 °F (100–250 °C)
Maxi Broil  For broiling meats e.g. steak, chops, kebabs, etc. The entire Browning / Broiling element will glow red to produce the required heat.	500 °F (240 °C)	400–575 °F (200–300 °C)
Broil  For grilling smaller quantities of steak, chops, kebabs, etc.	500 °F (240 °C)	400–575 °F (200–300 °C)
Convection Broil  This mode distributes hot air from the Browning/ Broiling element over the food using the fan. This allows for a lower temperature to be used than when using Broil  . Ideal for broiling thicker cuts of meat (e.g. chicken, roulades).	400 °F (200 °C)	200–500 °F (100–260 °C)
Gentle Bake  A combination of different heating elements ensures excellent baked good, gratins and lasagna.	350 °F (190 °C)	200–475 °F (100–250 °C)
Surround Roast  For roasting traditional recipes, e.g. pot roast, and braising or cooking at low temperatures.	400 °F (180 °C)	75–525 °F (30–280 °C)

Energy saving tips

- Remove any accessories from the oven that you do not require for cooking.
- Try not to open the door when cooking.
- If a temperature range is given, it is best to select the lower temperature and check the food after the shortest cooking time given.
- The default setting for the Time of Day display Time - Show - Off will consume the least amount of energy.
- With the factory default setting Lighting - On for 15 Seconds the oven interior lighting turns off automatically after 15 seconds. It can be turned on again at any time by touching "Light".
- When cooking with automatic shut-off or the roast probe, the oven heating will turn off automatically shortly before the end of cooking. The residual heat is sufficient to finish the cooking process. Energy Save Phase will appear in the display. The cooling fan or hot air fan (depending on mode used) will remain on.
- The oven turns off automatically if a button is not pressed to save power. The amount of time before the oven turns off depends on the selected settings, e.g. mode, temperature, cooking duration, etc.

Operating the oven

Quick Guide

- Turn the oven on.

The main menu will appear.

- Place the food in the oven.
- Select Operating Modes.
- Select the desired mode.

The oven mode and default temperature will appear.

The oven heating, lighting and cooling fan will turn on.

- Adjust the default temperature if necessary.

The default temperature will be automatically accepted within a few seconds. If necessary, select **Change** to go back to the temperature setting (see “Additional functions - Changing the temperature”).

- Confirm with OK.

The required and the actual temperatures will appear.

You will see the temperature rising in the display. A buzzer will sound when the oven temperature is reached if this option is selected (see “Settings - Audible tone information”).

After the cooking process:

- Remove the food from the oven.
- Turn the oven off.

Cooling fan

After the cooking process the cooling fan will continue to run for a while after a program is complete to prevent moisture from building up in the oven, on the control panel or surrounding cabinetry.



When the temperature in the oven has fallen sufficiently the cooling fan will turn off automatically.

The default setting can be changed if desired (see “Settings - Cooling Fan”).

You have placed the food in the oven, selected an operating mode and set the temperature.

- Select Change.

Additional options will appear in the display for you to select for change if desired.

- Temperature
- Core Temp. (This will only appear if you are using the roast probe. You cannot set a cooking duration when using the roast probe.)
- Duration
- Ready at
- Start at (This only appears if a Duration or Ready at time has been set.)
- PreHeating (This only appears in the Convection Bake / Convection Roast , Auto Roast , and Surround / Surround Roast  modes if you set a temperature above 212°F/100°C.)
- Operating Modes (You can change the mode while a cooking program is in process.)

Changing the oven mode

You can change the oven mode during operation.

- Select Change.
- Scroll through the list until Operating Modes appears.
- Select Operating Modes.
- Confirm with OK.

The new mode will appear in the display together with its default temperature.

- Change the temperature, if necessary.
- Confirm with OK.

The oven mode has been changed.

The times entered will be kept.

Additional functions

Changing the temperature

As soon as a cooking mode is selected, a default temperature will appear in the display together with its possible range (see the “Guide to the modes”).

- If the default temperature is suitable for your recipe, confirm it with OK.
- If it is not suitable for your recipe, you can change it for this particular cooking program.

You can also permanently reset the recommended temperature to suit your personal cooking habits (See “Settings - Default temperatures”).

Example: You have selected Convection Bake  and 350°F (170°C) and can see the temperature rising in the display.

You would like to reduce the target temperature to 310°F (155°C).

- Select Change.
- Select Temperature.

The desired temperature is highlighted.

- Changing the temperature
- Confirm with OK.



The adjusted temperature is saved.

- Confirm with OK, if you would like to see the actual temperature increasing in the display.

The altered set temperature appears.

Rapid PreHeat

Rapid PreHeat can be used to speed up the preheating phase.

The Rapid PreHeat function will turn on automatically if a temperature of more than 212°F (100°C) is set for Convection Bake , Auto Roast  and Surround .

Do not use Rapid PreHeat to preheat the oven when baking pizzas or delicates mixtures (e.g. small baked goods, sponge). These will brown too quickly.

You can turn off Rapid PreHeat for a relevant cooking process via the PreHeating option.

Preheating

- Rapid (Factory default)

The Browning / Broiling and ring heating elements turn on together with the fan to enable the oven to reach the required temperature as quickly as possible.

- Normal

Only the heating elements associated with the cooking program are turned on.

To turn the Rapid PreHeat function off:

- Select Change.
- Select PreHeating.
- Select Normal.
- Confirm with OK.
- Confirm with OK, if you would like to see the actual temperature increasing in the display.

Instead of Rapid PreHeat, Preheating will appear in the display.

- Select the required oven function and the temperature.
- Rapid PreHeat should be turned off when baking pizza or delicate mixtures.
- Wait for the preheating phase to complete.

When the set temperature is reached, the buzzer will sound if it has been turned on (see “Settings – Volume – Buzzer tone”).

- Place the food in the oven.

Setting additional durations

You have placed the food in the oven, selected a mode and set the temperature.

By entering Duration, Ready at or Start at you can automatically turn the cooking program on or off.

- Duration

Enter the cooking duration desired. Once the duration set has elapsed, the heating will turn off automatically. The maximum duration which can be set is 12 hours.

A cooking duration cannot be entered if you are using the roast probe. When using the roast probe, the cooking duration is determined by when the set core temperature is reached.

- Ready at

You can specify when you would like the cooking program to complete. The oven will turn off automatically at the time set.

A Ready at time cannot be entered if you are using the roast probe. When using the roast probe the end time is determined by when the set core temperature is reached.

- Start at

Set the time you would like cooking to start at. The oven will turn on automatically at the time set.

Start at can only be used together with Duration or Ready at, except when using the roast probe.

Additional functions

Turning off automatically

It is now 11:45. The food takes 30 minutes to cook and should be ready at 12:15.

Select **Duration** and set 0:30 h or select **Ready at** and set the time for 12:15.

The oven will switch off automatically after this duration has elapsed or the time set has been reached.

Setting the duration

- Select **Change**.
- Select **Duration**.
- Use the numerical keypad to set the duration (3-0).
- Confirm with **OK**.

Setting the “Ready at” time

- Select **Change**.
- Select **Ready at**.
- Use the numeric keypad to set the time when food should be ready (1-2-1-5).
- Confirm with **OK**.

Turning on and off automatically

It is recommended to use the automatic On/Off feature when roasting. Do not delay the start of the program for too long when baking. Cake mixtures and doughs will dry out, and the leavening agents will lose their effectiveness.

To turn a cooking program on and off automatically, you have a choice of how to enter the time parameters:

- **Duration** and **Ready at**
- **Duration** and **Start at**
- **Ready at** and **Start at**

It is now 11:45. The food takes 5 minutes to cook and should be ready at 12:30.

- Select **Change**.
- Select **Duration** and set a duration of 0:30 h.
- Select **Ready at** and set the time to 12:30 h.

The **Start at** time will be automatically calculated. **Start at 12:00** will appear in the display.

The oven will turn on automatically when this time is reached.

Sequence of a cooking program that turns on and off automatically

Up until the start time the mode, the selected temperature, *Start at* and the start time will appear in the display.

After the program has started you can follow the preheating phase in the display until the required temperature has been reached.

Once this temperature is reached, a buzzer will sound if turned on (see “Settings - Audible tone information”).

After the preheating phase the remaining time will appear in the display.

The time will count down in the display. The last minute counts down in seconds.

At the end of the cooking process a buzzer will sound if turned on (see “Settings - Audible tone information”).

The oven heating and lighting are turned on. *Program Finished* appears in the display.

You have the option to save the program as a favorite (see “Favorites”) or to increase the cooking duration using *Change*.

During the cooling down phase the cooling fan will continue to run.

Changing the set time

- Select *Change*.

All options that can be changed will appear.

- Select the desired time.
- Change the set time
- Confirm with *OK*.

These settings will be deleted in the event of a power failure.

Canceling cooking

- Select “*Back*”.
- When *Cancel Cooking?* appears, select *Yes*.

The oven heating and lighting will turn off, and any durations set will be deleted.

MasterChef

Your oven has a wide range of MasterChef programs that enable you to achieve excellent cooking results with ease. Simply select the appropriate program for the type of food you are cooking and follow the instructions in the display.

List of food types

The programs can be found under MasterChef.

- Poultry
- Meat
- Fish
- Pizza
- Baked Goods
- Potatoes

Using the MasterChef programs

- Select MasterChef.

A list of food types will appear on the display.

- Select the desired food type.

The MasterChef programs will then appear.

- Select the desired MasterChef program.

Each step you need to take before starting the MasterChef program will appear on the display.

Depending on the program, the following information will appear on the display:

- type of cookware,
- shelf level,
- using the roast probe,
- duration.
- Follow the instructions in the display.

Notes on using these programs

- After cooking, allow the oven interior to cool down to room temperature again before starting a MasterChef program.
- Some programs require a preheating phase before food can be placed in the oven. A prompt will appear indicating when to add the food.
- The duration quoted for MasterChef programs is an estimate. It may increase or decrease depending on the program. When using the roast probe, the duration will be determined by when the core temperature is reached. The duration, in particular with meat, will vary depending on the initial temperature of the food.

Favorites

You can create and save up to 20 of your own programs.

- Each one can have up to 10 cooking stages. This enables you to save your most frequently used recipes very accurately. In each stage you can select settings such as mode, temperature and duration or core temperature.
- You can specify the shelf level(s) for the food.
- You can enter a program name for your recipe.

When you next select the program, it will start automatically.

There are different ways of creating a Favorite:

- At the end of running a MasterChef Program, save it as a separate program.
- After running a program with a set duration, select Save.

Then name the program.

Creating a Favorite

- Select Favorites.

When first creating a program Create Program will appear in the display.

- Confirm with OK.

If the Favorite already exists, the program name will appear with Edit Program underneath.

- Select Edit Program.

- Select Create Program.

You can now specify the settings for cooking stage 1. Follow the instructions in the display:

- Select and confirm the settings.

The settings for the first cooking stage have now been set.

You can now adjust the settings for the PreHeating option, depending on the selected mode and the set temperature.

- Select Additional Parameters.

- Select the desired settings.

More cooking stages can be added, for example, if you would like to add another cooking mode to follow the first.

- If additional cooking stages are required, select **Add Cooking Stage** and proceed as you did for the 1st cooking stage.
- When you have completed setting the cooking stages. select **Complete Program**.

Set the shelf level(s) to be used:

- Select and confirm the required level(s).

A summary of your settings will appear in the display.

If you would like to change your program select **Change**. You can change individual cooking stages or add additional cooking stages.

- Confirm the settings and then select **Accept**.

You can now save or change your Favorite. You can also start it immediately or program it to turn on or off automatically at a specific time.

- Select **Save**.

You can now give the program a name. The following symbols appear next to the alphabet:

Symbol	Description
␣	Space
ABC	Alphabet in upper case
abc	Alphabet in lower case
123	Numbers 0 to 9 and hyphen -

- Touch the sensors next to the symbols to highlight the desired character.

- Select **Select**.

The letter or number you have selected will appear in the top line of the display.

You can delete the characters one at a time with "Back".

A maximum of 10 characters can be used.

- Finish creating the program name.
- Once you have entered the program name select **Save**.

A message will appear in the display confirming that the name has been saved.

- Confirm with **OK**.

Favorites

Starting a Favorite

- Place the food in the oven.
- Select Favorites.

The display shows the program names and **Edit Program** at the bottom.

- Select the desired program.

A list will appear in the display:

- Start Now

The program will start right away and the oven heating will turn on.

- Start Later

This option will only appear if you are using the roast probe. You can specify when you would like the program to start. The oven heating will turn on automatically at the time set.

- Start at

You can specify when you want the program to start. The oven heating will turn on automatically at the time you set.

- Ready at

You can specify when you would like the cooking program to complete. The oven will turn off automatically at the time set.

- Change Cooking Stages

More information on this menu item can be found in “Change cooking stages”.

- Select the desired menu item.
- Confirm the message regarding which shelf level to use with OK.

The selected program will begin automatically right away or at the time set.

Changing Favorites

Changing cooking stages

Cooking stages in a MasterChef program that have been saved under a different name cannot be changed.

- Select Favorites.

The display shows the program names and Edit Program at the bottom.

- Select the desired program.
- Select Change Cooking Stages.

The setting specified for a cooking stage can be changed or more cooking stages can be added to the program.

- Select the desired cooking stage or Add Cooking Stage.
- Alter the program as desired (see "Creating a Favorite").
- Confirm the settings and then select Accept.
- Select Save.

The changes made to the program will be saved.

- If necessary, change the name (see "Creating a Favorite) and select Save.

A message will appear in the display confirming that the name has been saved.

- Confirm with OK.

Changing the name

- Select Favorites.

The display shows the program names and Edit Program at the bottom.

- Select Edit Program.
- Select Change Program.
- Select the desired program.
- Select Change Name.
- Change the name (see "Creating a Favorite) and select Save.

A message will appear in the display confirming that the name has been saved.

- Confirm with OK.

The new program name will be saved.

Deleting a Favorite

- Select Favorites.

The display shows the program names and Edit Program at the bottom.

- Select Edit Program.
- Select Delete Program.
- Select the desired program.
- Confirm if the program should be deleted with Yes.

The program is deleted.



You can delete all of your Favorites at the same time (see "Settings - Factory Default - Favorites").

Bake

Eating food which has been cooked correctly is important for good health.



Only bake cakes, pizza, french fries, etc. until they are golden brown. Do not overcook them.

Oven modes

Depending on how you would like the food prepared, you can use Convection Bake , Intensive , or Surround .

Bakeware

The bakeware used depends on the oven mode chosen and how the food is prepared.

- Convection Bake , Intensive : Baking tray, Roasting pan, any heat-resistant baking dishes.
- Surround : Dark metal, enamel or aluminum baking tins with a matte finish, as well as heat-resistant glass, ceramic and coated dishes can be used. Avoid bright, shiny metal tins as they result in uneven or poor browning, and in some cases cakes might not cook properly.

- Always place baking pans on the wire rack. Position rectangular pans with the longer side across the width of the rack. This will allow for optimum heat distribution and even baking results.
- When baking cakes with fruit toppings or deep cakes, place the tin in the universal tray to catch any spills.

Parchment paper / Greasing the pan

All Miele accessories (baking tray, universal tray, perforated baking tray and round baking dish) are treated with PerfectClean finish.

Surfaces treated with PerfectClean finish generally do **not** need to be greased or covered with parchment paper.

Parchment paper is only needed with:

- anything with a high salt content (e.g. pretzels, bread sticks), because sodium can damage the PerfectClean surface;
- meringues or dishes with a high egg-white content, because they are more likely to stick,
- frozen food cooked on the wire oven rack.

Temperature

Select the suggested temperature if possible.



Choosing a baking temperature higher than those recommended may reduce the cooking time, but will lead to uneven browning, and unsatisfactory cooking results.

Baking duration

Check if the food is cooked at the end of the shortest duration quoted. To check if a cake is ready insert a wooden skewer or toothpick into the center, it should come out clean.

Shelf level

The shelf level that you place the food on for baking depends on the oven mode and the number of trays being used.

- **Convection Bake** 
 - 1 Tray: Level 2
 - 2 Trays: Levels 1+3/2+4
 - 3 Trays: Levels 1+3+5
- **Intensive** 
 - 1 Tray: Level 1 or 2
- **Surround** 
 - 1 Tray: Level 1 or 2



When cooking with the universal tray and baking tray(s) at the same time, place the universal tray below the baking tray(s).

Bake moist cakes and muffins on a maximum of two levels at the same time.

Roast

Always observe the USDA guidelines for food safety.

Oven modes

Depending on how you would like the food cooked, you can use Convection Bake / Convection Roast , Auto Roast , Surround / Surround Roast  or a MasterChef program.

Cookware



Any heat-resistant cookware can be used:

Wire oven rack, grilling and roasting insert (if available) on the universal tray, roasting pans, heat-resistant glass/earthen/cast iron dishes, roasting bags

Temperature

As a general rule, select the suggested temperature.

If higher temperatures are used, the meat will brown on the outside, but will not be properly cooked through.

When cooking with Convection Bake / Convection Roast  or Auto Roast  select a temperature approx. 25°F (20°C) lower than with Surround / Surround Roast .

Shelf levels

As a general rule use shelf level 2.

Tips

- Resting time: At the end of the program, take the roast out of the oven, cover with aluminum foil and let stand for about 10 minutes. This helps retain the juices when the meat is sliced.
- The larger the cut of meat, the lower the temperature setting should be.
- Use a roast probe for accurate cooking temperatures and best results.

Roast Probe

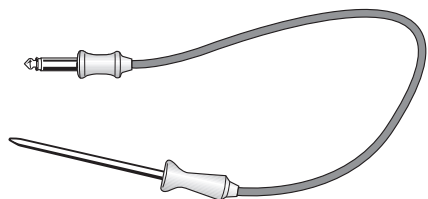

The roast probe enables the roasting process to be monitored simply and reliably.

How the roast probe works

The metal tip of the roast probe must be fully inserted into the centre of the food all the way to the handle. There is a temperature sensor in the metal tip which measures the core temperature of the food during cooking. The rise in the core temperature reflects the extent to which the food is cooked. You can program the core temperature to be lower or higher, depending on how you would like the meat cooked, rare, medium or well-done.





A core temperature of up to 210°F (99°C) can be set. Please refer to the roasting chart and “Slow cooking” for the core temperatures applicable for different types of meat.

The cooking time will be similar when cooking with or without the roast probe.

When to use the roast probe

Some MasterChef programs and Special modes will prompt you to use the roast probe.

You can also use it with your own Favorite programs and with the following functions:

- Auto Roast 
- Convection Bake / Convection Roast 
- Intensive 
- Surround / Surround Roast 
- Convection Broil 

Roast

Important notes regarding the roast probe

- The meat can be placed in a pot or on the rack in the universal tray.
- The metal tip of the roast probe must be fully inserted into the centre of the food all the way to the handle.
- When cooking poultry, insert the metal tip into the thickest part of the breast. You can find the thickest part of the breast by pressing the area with your thumb and index finger.
- Do not let the metal tip touch any bones or insert it into a fatty area of the meat. If fat or bone come into contact with the probe, this can lead to the oven being turned off too early.
- If the meat is very heavily marbled with fat, select the highest core temperature given in the roasting chart.
- When using roasting bags or aluminum foil, insert the probe through the bag or foil into the center of the meat. You can also place the meat, with the roast probe inserted, inside the foil. Follow the roasting bag / aluminum foil manufacturer's instructions.

Using the roast probe

- Insert the metal tip of the roast probe fully into the centre of the food all the way to the handle.
- Place the food in the oven.

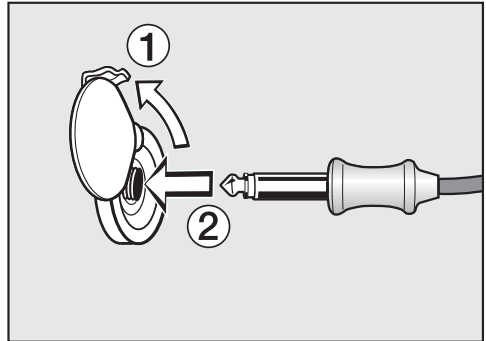

- Insert the plug of the roast probe into the socket until you feel it engage.
- Close the door.
- Select an oven mode or MasterChef program.
- If necessary, use the numeric keypad to set the temperature.
- If necessary use the numeric keypad to set the core temperature.

The core temperatures cannot be changed for the MasterChef programs.

You can also delay the start of the cooking program to a later time. To do this, select **Start at**.

You can estimate approximately when the food will be ready as the duration of the cooking program is about the same as if you were cooking food without using the roast probe.

Duration and **Ready at** cannot be set because the total time depends on how long it takes for the core temperature to be reached.

Time-left display

If the temperature set for a cooking process is above 285°F (140°C), the estimated duration remaining (time left) will appear in the display.

The time left is calculated from the cooking temperature selected, the set core temperature, and the progress of the core temperature as it rises.

The time left first shown is an estimate. As the cooking process continues, the time left is revised continuously, and a more accurate figure is shown.

The time left will be deleted if the cooking or core temperature is changed or if a different mode is selected. If the door is opened for a longer time, the time left will be recalculated.

Alternating between the time left and core temperature displays

As soon as the time left is shown, you can alternate between the time left and core temperature displays

- **Select Change.**
- **Select Status.**
- **Select whether you would like the time left or core temperature to appear in the display.**
- **Confirm with OK.**

Roast

Using residual heat

Shortly before the end of the cooking program the oven heating will turn off. The residual heat in the oven is sufficient to complete the cooking process.

Using the residual heat in the oven saves energy.

Energy Save Phase will appear in the display to show that the oven is in energy save mode. The measured core temperature is no longer visible.

The cooling fan and hot air fan (if turned on) will continue to run.

When the selected core temperature has been reached,

- Program Finished appears in the display,
- a buzzer will sound if turned on (see “Settings - Audible tone information”).

Tip: If the food is not sufficiently cooked, insert the roast probe into another place and repeat the program.

This cooking method is ideal for cooking beef, pork, veal or lamb when a tender result is desired.

First, using a cooktop sear the meat on all sides to seal in the juices.

Then place the meat in a preheated oven. It will be cooked at a low temperature for an extended time allowing the meat to become very tender.

The meat will rest and the juices start to circulate evenly throughout.

This gives the meat a very tender and juicy result.



Tips

- Use fresh, lean meat that has been trimmed. Remove the bones before cooking.
- When searing, use a suitable cooking oil or fat that can withstand high temperatures (e.g. clarified butter, vegetable oil).
- Do not cover the meat during cooking.

Cooking will take approx. 2-4 hours, depending on the size and weight of the meat, as well as the desired degree of doneness and browning.

Cooking time / Core temperatures

Always observe USDA food safety guidelines.

Meat	 [min]	 °F / °C
Beef Tenderloin	80–100	138/59
Sirloin		
– rare	50–70	118/48
– medium	100–130	135/57
– well done	160–190	156/69
Pork tenderloin	80–100	145/63
Smoked pork chop *	140–170	154/68
Filet of veal	80–100	140/60
Veal loin *	100–130	145/63
Saddle of lamb *	50–80	140/60

* boneless

After cooking:

Because the cooking temperatures are very low:

- The meat can be carved immediately. No resting time is required.
- The cooking result will not be affected if the meat is left in the oven after the program is complete. It can be kept warm until you serve it.
- The meat is at an ideal temperature to be eaten right away. Serve on pre-warmed plates with a hot sauce or gravy to keep warm.

Slow Roasting

Using the Slow Roasting function

- Select Special Modes.
- Select Slow Roasting.
- Set the required temperature.
- Set the core temperature.
- Follow the instructions on the display.
Let the wire oven rack and universal tray preheat in the oven.
- While the oven is preheating, sear the meat on all sides on the cooktop.

If the meat is not cooked to your satisfaction, you can extend the cooking time.

Burn hazard!

When the oven is hot use pot holders to insert, remove or turn the food, or when adjusting the oven shelves, etc.

- **Once** Use the roast probe appears in the display, place the seared meat on the rack and insert the roast probe, so that the metal tip is fully in the center of the meat.

For more information, see “Roast - Roast probe.”

Use Caution!

The browning / broiling element will be hot. Burn hazard!

- Insert the plug of the roast probe into the socket until you feel it engage.
- Close the door.

When the program is complete, Program Finished will appear in the display and a buzzer will sound if it has been turned on (see “Settings - Audible tone information”).

Adjusting the Slow Roasting temperature

Use the wire oven rack on top of the universal tray.
Do not use the Rapid PreHeat function to preheat the oven.

- Place the rack with the universal tray on shelf level 2.
- Select Surround or Surround Roast  and a temperature of 265°F (130°C).
- Change the preheating function by selecting Change - PreHeating - Normal.
- Preheat the oven with the universal tray and wire oven rack for approx. 15 minutes.
- While the oven is preheating, sear the meat on all sides on the cooktop.

Burn hazard!

When the oven is hot use pot holders to insert, remove or turn the food, or when adjusting the oven shelves, etc.

- Place the seared meat on the wire oven rack.
- Select Change.
- Select Temperature and set 210°F (100°C).
- Continue cooking until the end of the cooking time.

You can set the cooking program to switch off automatically (see “Additional functions - Setting the cooking time”).

Broil



Danger of burns!

Broil with the oven door closed. If you broil with the door open the hot air will escape from the oven before it has been cooled by the cooling fan.

The controls will get hot.

Oven modes

Maxi Broil

This mode delivers excellent browning and broiling results when cooking larger amounts of food. Use to broil chops, ribs and large quantities of meat and for browning large dishes.

The entire Browning/Broiling element will become red hot to produce the necessary heat.

Broil

This mode delivers excellent browning and broiling results when cooking smaller amounts of food. Use to broil chops, ribs and small quantities of meat and for browning small dishes.

Only the center of the Browning/Broiling element will become red hot to produce the necessary heat.

Convection Broil

For broiling thicker items, e.g. poultry or London broil.

The Browning/Broiling element and the fan switch on in alternating phases.

Cooking accessories

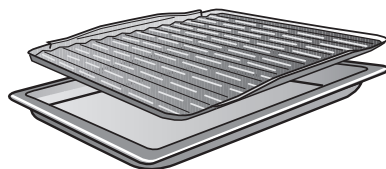
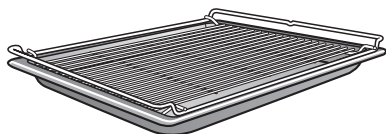

Use the universal tray with the wire oven rack or grill and roasting insert (if available) on top. The insert protects the oven from splatter and collects the juices underneath. The juices can then be used for gravy and sauces.

Do not use the baking tray.

Temperature

As a general rule, select the default temperature.

If higher temperatures are used, the meat will brown on the outside, but will not be properly cooked through.

Preheating

Always preheat the oven for about 5 minutes with the door closed before Broiling.

Shelf levels

Select the shelf level according to the thickness of the food.

- Thin cuts: Shelf level 3 or 4
- Thick cuts: Shelf level 1 or 2

Broiling time

Flat pieces of fish and meat usually take 6–8 minutes per side.

When broiling thicker pieces, each side will take a bit longer. Make sure that the pieces have roughly the same thickness so that their broiling times do not vary too greatly.

Testing doneness

Always observe USDA food safety guidelines.

Tip: If the surface of a thicker cut of meat is browned but the center is still raw, move the food to a lower level or reduce the temperature and continue cooking. This will stop the surface from becoming too dark.

Preparing food for broiling

Rinse the meat under cold water and pat dry. Do not season the meat with salt before broiling, this will draw out the juices.

Brush the meat with oil, if necessary. Do not use other types of fat as they can easily burn and cause smoke.

Clean fish as usual. To enhance the flavor, salt or lemon can be added.

Broil

- Place the wire oven rack or the grilling and roasting insert (if available) in the universal tray.
- Place the food on top.
- Select the required oven mode and temperature.
- Preheat the Browning / Broiling element for approx. 5 minutes with the door closed.

Danger of burns!

When the oven is hot use pot holders to insert, remove or turn the food, or when adjusting the oven shelves, etc.

- Place the food on the appropriate shelf level (see the Broiling chart).
- Close the door.
- Turn the food halfway through cooking.

Special Modes

In addition to the MasterChef programs your oven has a variety of Special Modes.

- Defrost
- Dehydrate
- Reheat
(to reheat plated meals)
- Warm Cookware
- Proof
- Slow Roasting
See “Slow Roasting” for more information.
- Pizza
- Sabbath Program

This section also gives information on the following applications:

- Gentle Bake
- Canning
- Frozen food

Defrost

Use the Defrost function to gently defrost frozen food.

The temperature can be set between 75-150°F (25-50°C).

- Select Special Modes.
- Select Defrost.
- If necessary, adjust the default temperature and set the duration.
- Follow the instructions on the display.

Air is circulated throughout the oven cavity to gently defrost the food.

 Risk of salmonella poisoning!
Be sure to strictly observe proper hygiene rules when defrosting poultry.
Do not use the liquid from the defrosted poultry.

Tips

- Remove the packaging and place the frozen food on the universal tray or in a suitable bowl or dish.
- When defrosting poultry, place it on the wire oven rack and position the rack on the universal tray so that the poultry does not sit in the defrosting liquid.

Dehydrate

This program is designed for traditional drying of food to preserve it.

The temperature can be set between 175-250°F (80-100°C).

It is important that fruit and vegetables are ripe and not bruised before they are dehydrated.

- Prepare the food for dehydrating.
 - Peel and core apples, and cut into slices 1/4" (.5 cm) thick.
 - Core plums if necessary.
 - Peel, core and cut pears into wedges.
 - Peel and slice bananas.
 - Clean mushrooms, then either halve or slice them.
 - Remove parsley and dill from the stem.
- Distribute the food evenly over the roasting pan.

You can also use the Gourmet perforated baking tray, if you have one.

Special Modes

- Select Special Modes.
- Select Dehydrate.
- If necessary, adjust the default temperature and set the duration.
- Follow the instructions on the display.

Food	⌚ [min]
Fruit	120-480
Vegetables	180-480
Herbs *	50-60

⌚ Dehydrating time

* Because this program uses the fan, you should use Surround mode  set to a temperature of 175-250°F (80-100°C) for drying herbs.

- Reduce the temperature if condensation begins to form in the oven.

 **Danger of burning!**
Use pot holders when removing the food from the oven.

- Allow the fruit or vegetables to cool down after dehydrating.

Dried fruit must be completely dry, but also soft and elastic. Juice should not escape when cut.

- Store in sealed glass jars or tins.

Reheat

This mode is designed to reheat cooked food.

Available options are:

- Pizza
- Large Oven Dish
- Bakes

Use heat-resistant cookware.

- Place the food that is to be reheated in a dish, and place the dish on the wire rack. Do not cover.
- Select Special Modes.
- Select Reheat and change the default temperature if necessary.
- Follow the instructions in the display.

 **Burn hazard!**
Use pot holders when removing dishes from the oven. Condensation may accumulate on the bottom of the dish.

Warm-up Cookware

This program is designed to warm your cookware.

The temperature can be set between 75-175°F (50-80°C).

Use heat-resistant cookware.

- Place the rack on shelf level 2 and place the cookware to be heated on it.
- Select Special Modes.
- Select Warm Cookware.
- If necessary, adjust the default temperature and set the duration.
- Follow the instructions on the display.



Danger of burns!

Use pot holders when removing dishes from the oven. Condensation may accumulate on the bottom of the dish.

Proof

This mode is designed specifically for proofing dough.

You can set a temperature between 75 and 125°F (30 and 50°C).

- Select Special Modes.
- Select Proof.
- If necessary, adjust the default temperature and set the duration.
- Follow the instructions in the display.

If you would like to proof dough with the addition of moisture, select the appropriate MasterChef program.

Special Modes

Pizza

This program is designed specifically for baking pizza.

The temperature can be set between 300-475°F (160-250°C).



- Select Special Modes.
- Select Pizza.
- If necessary, adjust the default temperature and set the duration.
- Follow the instructions on the display.

Sabbath Program

This program is designed for religious observance.

Select the Sabbath Program and then select the oven mode and temperature.

The program will only start once the door is opened and closed:

- The cooking process will start after about 5 minutes using Surround  or Bake .
- The oven will heat up to the temperature you have set and will maintain this temperature for a maximum of 72 hours.
- The interior lighting does not come on, even when the door is opened.

If Settings - Lighting - On has been selected, the lighting will remain turned on throughout the program.

- Sabbath Program will appear in the display throughout the entire program.
- The time of day is turned off.

Once the Sabbath Program has started is cannot be changed or saved as a Favorites.

Using the Sabbath Program

The program can only be canceled by turning the oven off.

- Select Special Modes.
- Select Sabbath Program.
- Select the desired mode.

The Sabbath Program cannot be started if the timer is being used.

- Set the required temperature.
- Confirm with OK.

The oven is now ready for use.

- Open the door to start the program.
- Place the food in the oven.
- Close the door.

The oven heating will turn on after 5 minutes.

To end the program early:

- Turn the oven off.

Gentle Bake

The Gentle Bake mode is ideal for casseroles and gratins.

You can select a temperature setting from 200-475°F (100-250°C).

- Select Operating Modes.
- Select Gentle Bake and change the default temperature if necessary.
- Follow the instructions on the display.

Special Modes

Canning

Always observe USDA food safety guidelines.

Canning containers

 **Danger of injury!**
Do not use the appliance to heat up or can food in sealed jars or containers. Pressure will build up inside them and they can explode causing damage to the appliance, as well as the risk of injury and scalding.

Only use jars designed for canning:

- Canning jars
- Jars with twist-off lids

Canning fruit and vegetables

We recommend using the Convection Bake  mode.

The instructions below are for 6 one-liter glass jars.

- Slide the universal tray onto shelf level 2. Place the jars on the tray.
- Select the Convection Bake  mode and a temperature of 300-340°F (150-170 °C).
- Wait until bubbles rise evenly in the jars.

Then reduce the temperature to avoid a boil-over.

Fruit / Cucumbers

- As soon as bubbles begin to rise evenly in the jars, reduce the temperature to the lowest setting. Then, leave the jars in the warm oven for an additional 25-30 minutes.

Vegetables

- Reduce the temperature to 210°F (100°C) as soon as bubbles begin to rise evenly in the jars.
- After the canning time has finished, reduce the temperature to the lowest setting and leave the jars in the oven for an additional 25-30 minutes.

After canning

 **Danger of burns!**
Use pot holders when removing the jars from the oven.

- Take the jars out of the oven.
- Cover the jars with a towel and leave to set for approx. 24 hours.
- Make sure all jars are closed properly when storing them.

Frozen food

Tips for pizza, French fries, croquettes and other similar items

Cakes, pies, pizza, baguettes

- Bake frozen pizza on parchment paper placed on the wire oven rack.
- Cook smaller frozen food items on parchment paper placed on a baking tray or the universal tray.
- For smaller frozen food items, use the lowest temperature recommended on the packaging.
- Turn small frozen food items several times during cooking.

Preparation

Handling food carefully will help protect your health.

- Select the oven mode and temperatures recommended on the food's packaging.
- Preheat the oven.
- Place the food in the preheated oven on the shelf level recommended on the packaging.
- Check the food at the end of the shortest time recommended on the packaging.

Cleaning and care



Danger of burns!

Make sure the heating elements are turned off and allowed to cool completely.



Danger of injury! The steam from a steam cleaner could reach electrical components and cause a short circuit.

Do not use a steam cleaner to clean this appliance.

All surfaces can discolor or be damaged if unsuitable cleaning agents are used. The front of the oven, in particular, will be damaged by oven cleaners and descalers.

All surfaces are susceptible to scratches. Scratches on glass surfaces could cause a breakage.

Remove any cleaning agent residues immediately.

Unsuitable cleaning agents

To avoid damaging surfaces when cleaning, do not use:

- Cleaners containing soda, ammonia, acids or chlorides
- Lime removers on the front of the ovens
- Abrasive cleaning agents, such as scouring powder, scouring cream, pumice stones
- Solvent-based cleaners
- Stainless steel cleaners
- Dishwasher cleaners
- Glass cleaners
- Ceramic cooktop cleaners
- Hard, abrasive sponges and brushes, such as pot scrubbers or used sponges that still contain traces of abrasive cleaner
- Eraser sponges
- Sharp metal scrapers
- Steel wool
- Spot cleaners
- Oven cleaners
- Stainless steel scouring pads

If stains and food residues are allowed to remain on surfaces for a longer period of time, it may no longer be possible to remove them. Continued use without cleaning will make the oven much harder to clean.

Remove any soiling immediately.

The accessories are not dishwasher-safe.

Tips

- Soiling caused by spilt juices and cake mixtures is best removed while the oven is still warm. Use caution and make sure the oven is not too hot - Danger of burns.
- For easier cleaning, the oven door can be disassembled. Remove the side runners, the catalytic back panel and fold down the Browning / Broiling element.

Normal soiling

See “Cleaning the catalytic enameled back panel” for cleaning instructions.

- Remove normal soiling immediately using a clean sponge with warm water and liquid dish soap applied with a clean, damp microfiber cloth.
- After cleaning, ensure that any detergent residue is removed with clean water. This is particularly important when cleaning surfaces treated with PerfectClean enamel as detergent residue can impair the non-stick properties.
- After cleaning, dry the surfaces with a soft cloth.

Cleaning the seal

There is a seal around the oven cavity which ensures that the interior of the oven and the inside of the door are sealed.

Grease deposits on the seal can cause it to become brittle and cracked.

- Wipe the seal clean after each use.

Roast Probe

 Do not put the roast probe into water or clean it in the dishwasher, this will damage it. Clean the roast probe with a damp towel.

Cleaning and care

Stubborn soiling (excluding the FlexiClip runners)

Spilt fruit and roasting juices may permanently discolor surfaces of the oven. This discoloration is permanent but will not affect the performance of the oven. Do not use force to remove these stains. Clean using the instructions in this manual.

- Baked on deposits can be removed with a glass scraper or a non-abrasive stainless steel spiral pad.

Remove the catalytic panels before using oven cleaners. They will damage the catalytic enamel.

- Stubborn soiling on PerfectClean surfaces can be cleaned using Miele Oven Cleaner. It must only be applied to cold surfaces in accordance with the instructions on the packaging.

Non-Miele oven spray must only be used in a cold oven and for no longer than 10 minutes.

- If necessary, the rough side of a dish sponge can be used to remove the soiling.
- After cleaning, remove all oven cleaning agent residues thoroughly with clean water, and dry with a soft cloth.

Stubborn soiling on the FlexiClip runners

Do not wash the FlexiClip telescopic runners in the dishwasher. This will remove the special lubricant which is essential for their smooth functioning.

For stubborn surface soiling or if the bearings become sticky proceed as follows:

- Soak the FlexiClip runners for approx. 10 minutes in warm water and liquid dish soap.
If necessary, use the rough side of a dish sponge. The bearing can be cleaned using a soft brush.

After cleaning discolorations or lighter areas may remain on the runners. This will not affect the performance in any way.

Cleaning the catalytic enameled back panel

Soiling from oil and fat is burnt off catalytic enamel when very high temperatures are used in the oven.

The higher the temperature, the more effective the process.

Exposure to scouring agents, abrasive brushes or sponges and oven sprays can cause the catalytic enamel to lose its self-cleaning properties.
Catalytic enameled panels should be removed before using oven spray.

Removing soiling caused by spices, sugar and similar deposits.

- Remove the back panel (see “Cleaning and care - Removing the back panel”).
- Wash the back panel by hand with warm water and liquid dish soap applied with a soft sponge.
- Rinse thoroughly and let dry before placing it back in the oven.

Cleaning and care

Removing oil and grease

- Remove any accessories from the oven, including the shelf runners.
- Wipe any soiling from the oven interior and the inside of the door before starting the cleaning process. This will avoid them baking on.
- Select Convection Bake  and 475°F (250 °C).
- Heat the empty oven for at least 1 hour, or more depending on the degree of soiling.

If the catalytic coating is very heavily soiled with oil and grease, a film can form on the surfaces of the oven interior during the cleaning process.

 To prevent burns, allow the heating elements to cool before cleaning by hand.

- Clean the inside of the door and the oven interior with warm water and liquid dish soap, applied with a clean, damp microfiber cloth.

Any remaining soiling will gradually disappear with each subsequent use of the oven at a high temperature.

Door removal

The door weighs approx. 19 lbs (9 kg).

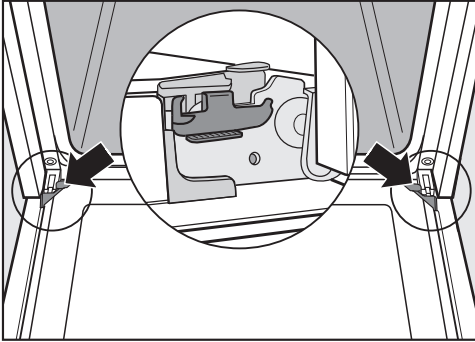

The oven door is connected to the hinges by retainers. Before removing the door from the retainers, the locking clamps on both hinges have to be released.

- Open the door fully.

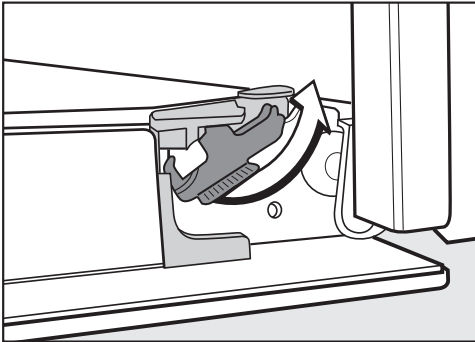

- Release the locking clamps by turning them as far as they will go.

Do not pull the door horizontally off its retainers, as they will spring back against the oven.

Do not pull the door off the retainers by the handle, as the handle could break off.

- Raise the door up till it rests partially open.



- Hold the door on either side and pull it diagonally upwards from the hinge guides. Make sure that you lift the door off straight.

Cleaning and care

Reinstalling the door

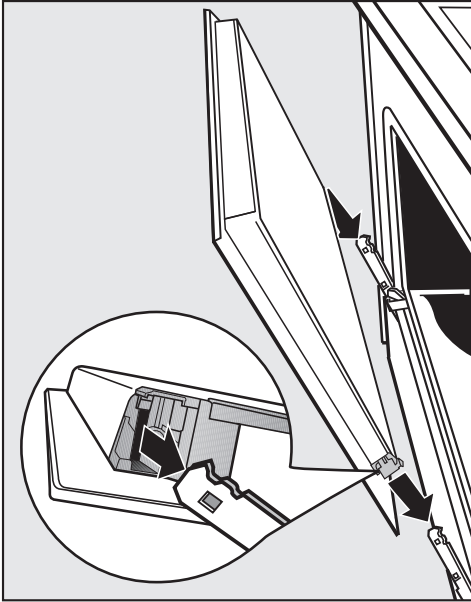

- Hold both sides of the door securely and carefully fit it onto the brackets of the hinges. Make sure that the door goes on straight.

- Open the door fully.

If the locking clamps are not locked, the door can easily become detached from the brackets and be damaged.

You must make sure that the locking clamps are locked again.

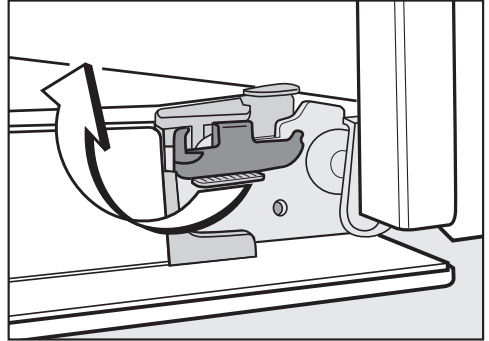

- To relock the locking clamps, turn them back up to the horizontal position as far as they will go.

Removing the shelf runners with FlexiClip telescopic runners

⚠ Danger of injury!
Do not use the oven without the shelf runners correctly inserted.

The shelf runners can be removed together with the FlexiClip telescopic runners (if inserted).

If you wish to remove the FlexiClip telescopic runners separately, follow the instructions in “Features – Inserting and removing the FlexiClip telescopic runners”.

⚠ Danger of burns! Make sure the heating elements are turned off and that the oven cavity is cool.

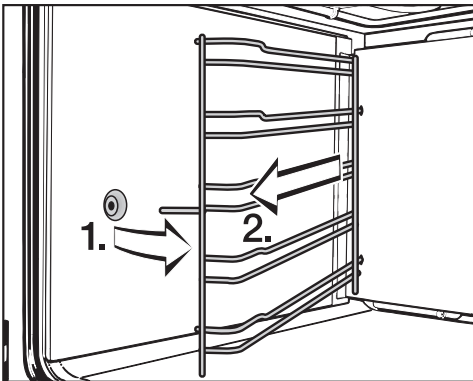

- Pull the runners out of the holder (1.) at the front of the oven, and then pull them out of the oven (2.).

The runners can be **reinstalled** in the reverse order.

- Be sure that all parts are installed correctly.

Removing the back panel

⚠ Danger of injury!
Do not use the oven without the back panel in place.

The back panel can be removed for cleaning purposes.

⚠ Danger of burns! Make sure the heating elements are turned off and that the oven cavity is cool.

- Disconnect the appliance from the power supply.
- Remove the shelf runners.
- Loosen the four Torx screws (T20) at the corners of the back panel and remove it.
- Clean the back panel (see “Cleaning the catalytic enameled back panel”).

The back panel can be **reinstalled** in the reverse order.

- Be sure that the back panel is installed correctly.

See “Guide to the oven” for arrangement of the openings.

- Reconnect the oven to the electrical supply.

Cleaning and care

Lowering the Browning/ Broiling element



Danger of burns!

Make sure the heating elements are turned off and allowed to cool completely.

- Remove the shelf runners.

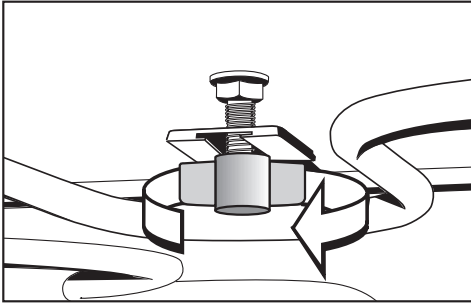

- Unscrew the wing nut.

Use caution not to damage the Browning/Broiling element.

Do not use force to lower the Browning/Broiling element.

- Carefully lower the Browning/Broiling element.

The ceiling can now be cleaned.

- Raise the Browning/Broiling element and tighten the wing nut securely.
- Reinsert the shelf runners.

Frequently Asked Questions

With the help of the following guide minor faults in the performance of the machine, some of which may result from incorrect operation, can be remedied without contacting the Service Department.



This guide may help you to find the reason for the fault, and how to correct it.

Problem	Possible cause and solution
The display is dark.	<p>The time of day display is deactivated. When the appliance is turned off, the time of day display is turned off.</p> <ul style="list-style-type: none"> ■ As soon as the oven is turned on, the time of day will appear. If you want it to be displayed continuously, the setting to turn the time of day display back on must be changed (see “Settings – Time of day – Display”). <p>There is no power to the appliance.</p> <ul style="list-style-type: none"> ■ Check if the breaker has tripped. If it has, contact a qualified electrician or Miele Technical Service.
System Lock  in the display when the oven is turned on.	<p>The system lock is On.</p> <ul style="list-style-type: none"> ■ Press and hold the icon for at least 6 seconds to unlock the oven for 1 cooking program. ■ To permanently deactivate the lock, see “Setting - System Lock”.
The oven does not heat up.	<p>Demo mode is activated. The oven can be operated but will not heat up.</p> <ul style="list-style-type: none"> ■ Deactivate Demo mode (see “Settings – Showroom Program”).
Power Failure - Program Canceled appears in the display.	<p>There has been a power failure which has caused the current cooking process to stop.</p> <ul style="list-style-type: none"> ■ Turn the oven off and then back on again. ■ Restart the cooking process.
12:00 appears in the display.	<p>The power supply was interrupted for longer than 200 hours.</p> <ul style="list-style-type: none"> ■ Reset the date and time.
Maximum Operating Hours Reached appears in the display.	<p>The oven was operated for an unusually long period of time. The Safety cut-out feature has been activated.</p> <ul style="list-style-type: none"> ■ Confirm with OK. Clear the message Program Finished by selecting “Back”. <p>The oven is now ready to use.</p>

Frequently Asked Questions

Problem	Possible cause and solution
 Fault XX appears in the display.	A fault has occurred that you cannot resolve. ■ Contact Miele.
The core temperature cannot be set.	The roast probe is not recognized by the oven. ■ Check whether the roast probe is correctly plugged into the socket. If the oven still does not recognize the roast probe, it must be faulty. A replacement roast probe can be ordered from Miele.
A noise is heard after the cooking process is complete.	The fan remains turned on after a cooking program (see “Settings - Cooling fan”).
The oven has turned itself off.	The oven turns off automatically if a button is not pressed after a certain amount of time or after a cooking program has ended to save power. ■ Turn the oven back on.
Spots appear on the catalytic surfaces.	The catalytic cleaning process does not remove spices, sugar or similar deposits. ■ Remove the catalytic panels and clean this type of soiling with warm water and liquid dish soap applied with a soft brush (see “Cleaning and care - Cleaning the catalytic enameled back panel”).
Baked goods are not cooked properly after following the times given in the chart.	A different temperature than that given in the recipe was used. ■ Select the temperature required for the recipe. The ingredient quantities are different from those given in the recipe. ■ Double check the recipe. The addition of more liquid or more eggs will make a wetter mixture which will take longer to cook.

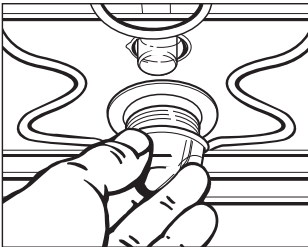
Frequently Asked Questions

Problem	Possible cause and solution
<p>The browning is uneven.</p>	<p>The wrong temperature or shelf level was selected.</p> <ul style="list-style-type: none"> ■ There will always be a slight unevenness. If the unevenness is great, check whether the correct temperature and shelf level were selected. <p>The material or color of the bakeware is not suitable for the oven mode selected.</p> <ul style="list-style-type: none"> ■ When using Surround  use matte, dark colored pans. Light colored, shiny pans will not produce as desirable results.
<p>The FlexiClip telescopic runners do not push in or pull out smoothly.</p>	<p>The bearings in the FlexiClip telescopic runners are not sufficiently lubricated.</p> <ul style="list-style-type: none"> ■ Lubricate the bearings with the special Miele lubricant. <p>Only use this special lubricant as it is designed to withstand high temperatures in the oven. Other lubricants can harden and stick to the telescopic runners when they are heated. The Miele lubricant is available to order from Miele.</p>
<p>The oven lighting turns off after a short time.</p>	<p>The oven is factory set to turn off automatically after 15 seconds. This setting can be changed (see “Settings - Lighting”).</p>
<p>The top oven lighting does not turn on.</p> 	<p>The halogen bulb needs to be replaced.</p> <div style="border: 1px solid gray; padding: 5px; margin-bottom: 10px;"> <p> Danger of burns! Make sure the heating elements are turned off and allowed to cool completely.</p> </div> <ul style="list-style-type: none"> ■ Disconnect the appliance from the power supply. ■ Turn the lamp cover a quarter turn counter-clockwise to release it and then pull it together with its seal downwards to take it out. ■ Replace it with a new halogen bulb (Sylvania 66740, 120 V, 40 W, G9, FS1). ■ Refit the lamp cover together with its seal and turn it clockwise to secure. ■ Reconnect the oven to the electrical supply.

Frequently Asked Questions

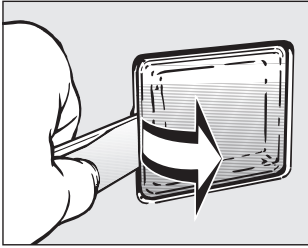
Problem	Possible cause and solution
<p data-bbox="76 202 356 260">The side oven lighting does not turn on.</p> 	<p data-bbox="400 202 874 229">The halogen bulb needs to be replaced.</p> <div data-bbox="404 236 1046 363" style="border: 1px solid gray; padding: 5px;"><p data-bbox="418 248 667 284">⚠ Danger of burns!</p><p data-bbox="418 292 1020 349">Make sure the heating elements are turned off and allowed to cool completely.</p></div> <ul data-bbox="400 387 1025 683" style="list-style-type: none"><li data-bbox="400 387 1025 416">■ Disconnect the appliance from the power supply.<li data-bbox="400 424 1025 453">■ Remove the side runners.<li data-bbox="400 461 1025 518">■ Loosen the bulb cover with the tool supplied from the frame.<li data-bbox="400 526 1025 584">■ Replace it with a new halogen bulb (Sylvania 66740, 120 V, 40 W, G9, FS1).<li data-bbox="400 592 1025 649">■ Press the lamp cover back into its frame and refit the side runners.<li data-bbox="400 657 1025 683">■ Reconnect the oven to the electrical supply.

Contact in case of fault

In the event of a fault which you cannot remedy yourself, please contact your Miele dealer or Miele Technical Service.

Contact information for Miele Technical Service can be found at the end of this document.

Please quote the model and serial number of your appliance when contacting Miele. Both pieces of information can be found on the data plate.

The data plate is visible on the front frame of the oven, with the door fully open.

Warranty

For further information, please refer to your warranty booklet.

Caring for the environment

Disposal of the packing material

The cardboard box and packing materials protect the appliance during shipping. They have been designed to be biodegradable and recyclable.

Ensure that any plastic wrappings, bags, etc. are disposed of safely and kept out of the reach of children.
Danger of suffocation!

Disposal of your old appliance

Electrical and electronic appliances contain valuable materials. They also contain certain substances, compounds and components which were essential for the proper functioning and safe use of the equipment. Handling these materials improperly by disposing of them in your household waste can be harmful to your health and the environment. Therefore, please do not dispose of your old appliance with regular household waste and follow local regulations on proper disposal.



Consult with local authorities, dealers or Miele in order to dispose of and recycle electrical and electronic appliances. Miele assumes no responsibility for deleting any personal data left on the appliance being disposed. Please ensure that your old appliance is kept away from children until removal. Observe safety requirements for appliances that may tip over or pose an entrapment hazard.

CAUTION:

Before servicing, disconnect the power supply by either removing the fuse, shutting off the power main or manually “tripping” the circuit breaker.

Installation, repair and maintenance should be performed by a Miele authorized service technician. Work by unqualified persons could be dangerous and may void the warranty.

Before connecting the appliance to the power supply, make sure that the voltage and frequency listed on the data plate correspond with the household electrical supply. This data must correspond to prevent machine damage. Consult an electrician if in doubt.

Only operate the appliance after it has been installed into cabinetry.

The plug must be inserted into a suitable outlet that has been installed and grounded in compliance with all applicable local regulations.

WARNING: THIS APPLIANCE MUST BE GROUNDED

Installer: Please pass these instructions on to the customer.

Electrical connection

The oven is equipped with a power cord approx. 5' 6" (1.7 m) in length with a NEMA 14-30 P plug ready for connection to the power supply:

– 120/208 V, 20 A, 60 Hz

or

– 120/240 V, 20 A, 60 Hz

The voltage can be adjusted (see “Settings - Electrical Version”).

SAVE THESE INSTRUCTIONS FOR THE ELECTRICAL INSPECTOR'S USE.

Installation diagrams

Appliance and cut-out dimensions

Miele ovens can be installed flush or proud. Discuss your installation requirements with your architect, designer and installer.

Undercounter installation

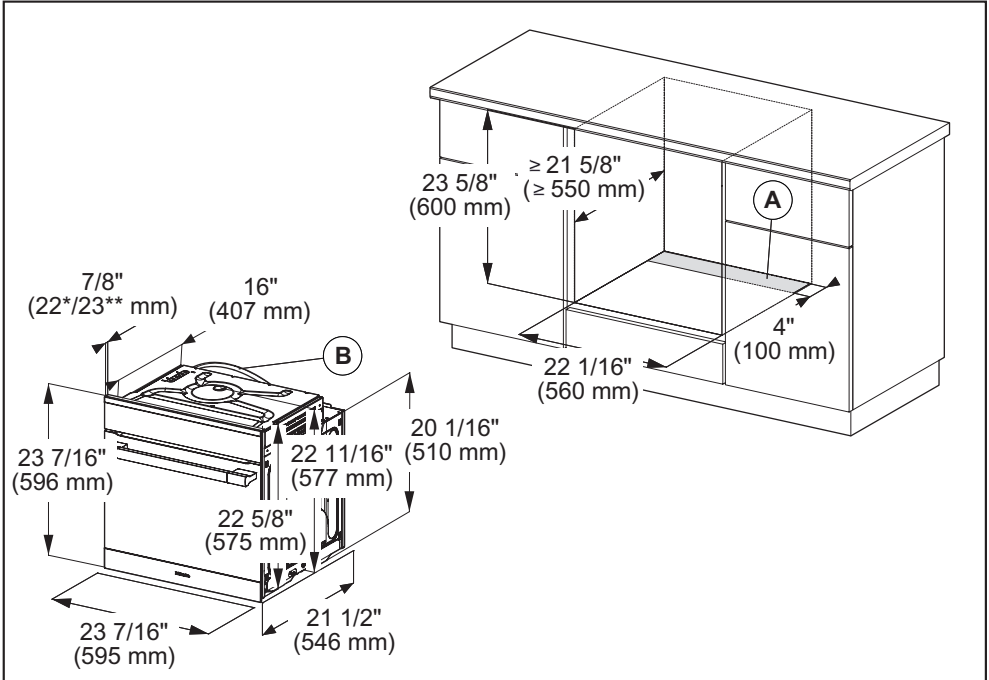

- Ⓐ Cut-out (4" x 22" / 100 mm x 560 mm) in the bottom of the cabinet for power cord and ventilation
 - Ⓑ Power cord with plug
- * Oven with glass front
** Oven with metal front

Depending on the model, the oven front may differ from the one shown the drawing. Current specifications can be found on the Miele website.

Installation into a tall cabinet

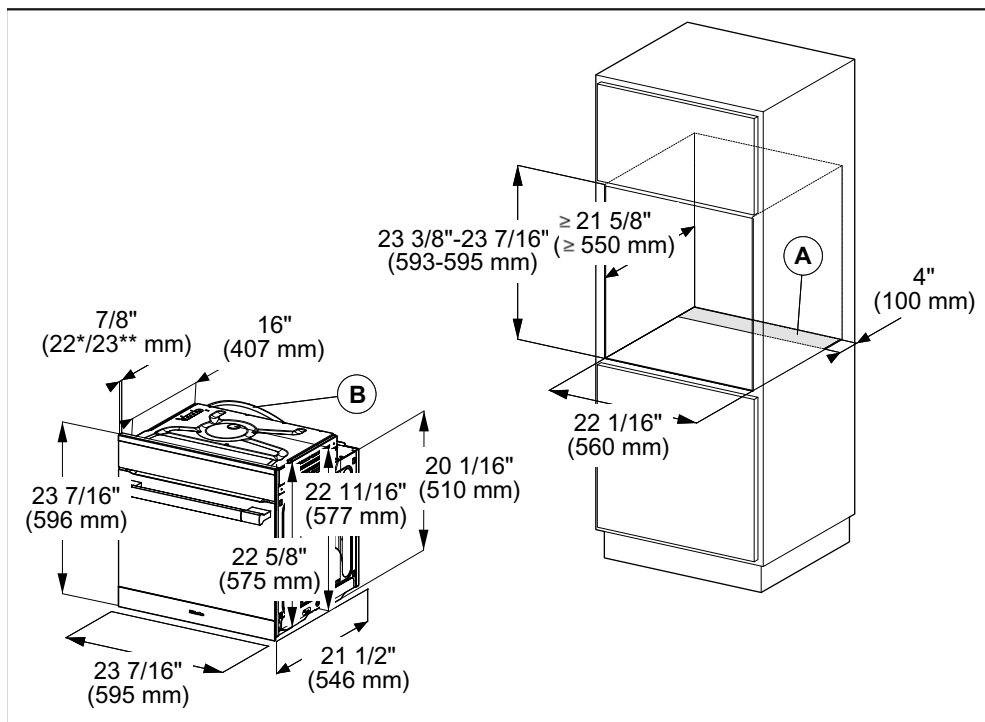

- Ⓐ Cut-out (4" x 22" / 100 mm x 560 mm) in the bottom of the cabinet for power cord and ventilation
- Ⓑ Power cord with plug
- * Oven with glass front
- ** Oven with metal front

Depending on the model, the oven front may differ from the one shown the drawing. Current specifications can be found on the Miele website.

Installation diagrams

Front dimensions

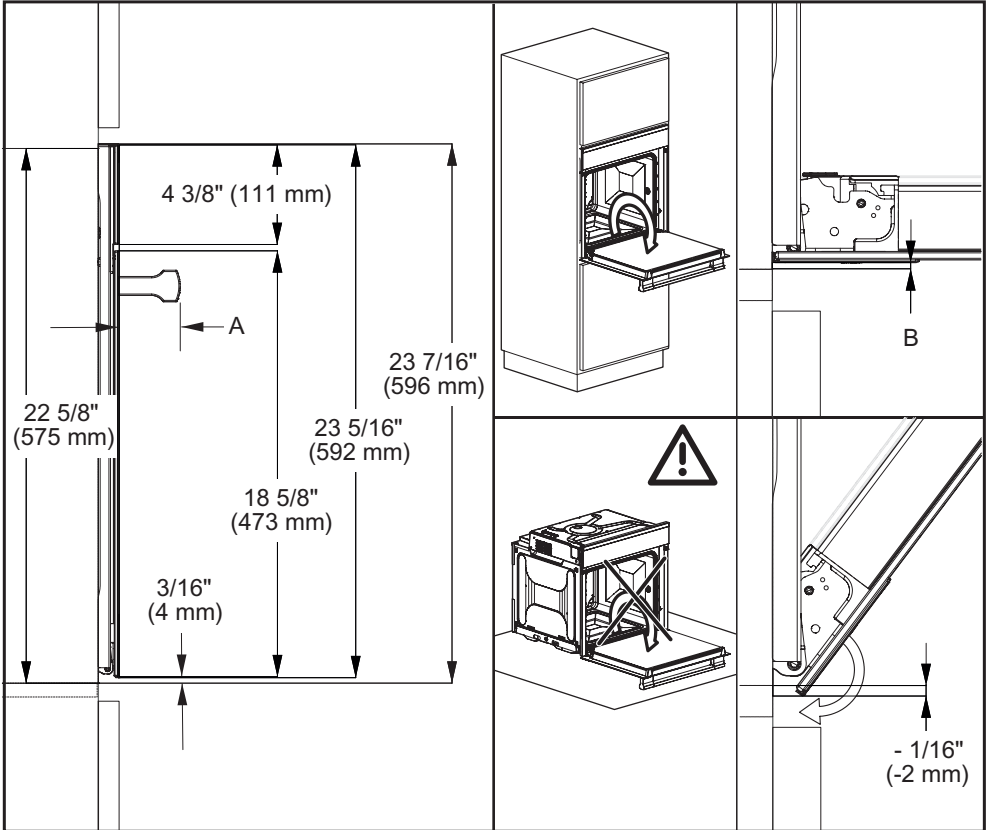

A H65xx: $2 \frac{11}{16}''$ (69 mm)

H66xx: $1 \frac{5}{8}''$ (42 mm)

B Oven with glass front: $\frac{1}{16}''$ (2.2 mm)

Oven with metal front: $\frac{1}{16}''$ (1.2 mm)

 The oven must not be operated until it has been properly installed within cabinetry.

In order for the oven to function correctly, it required an adequate supply of cool air. Ensure that the air flow is not impaired (e.g. insulation in the cabinetry). Also be sure that the cool air supply is not heated by other sources nearby.

Before installation

- Before connecting the oven to the power supply, first disconnect the power supply from the oven isolator switch.

Mounting the door handle (depending on model)

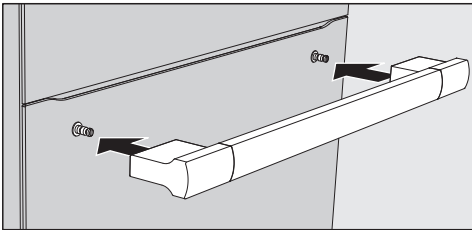

- Mount the handle onto the retaining bolts.

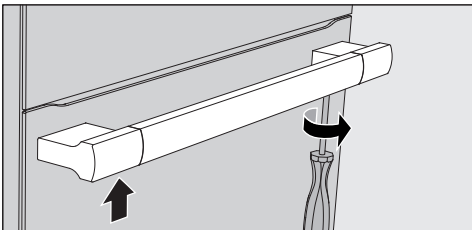

- Use the supplied Allen wrench to tighten all four bolts.

Installing the oven

- Connect the power cord to the electrical supply.

Do not carry the oven by the door handle. The door can be damaged. Use the handles on each side of the oven to carry it.

It is recommended that you remove the door before installing the appliance (see “Cleaning and Care - Removing the door”) and all oven accessories from the cavity. This will make for easier installation into the niche and will not tempt you to use the handle to carry it.

- If there are side handles, please remove them.
- Push the oven into the cabinetry and align it.
- Open the door (if it was not removed previously).

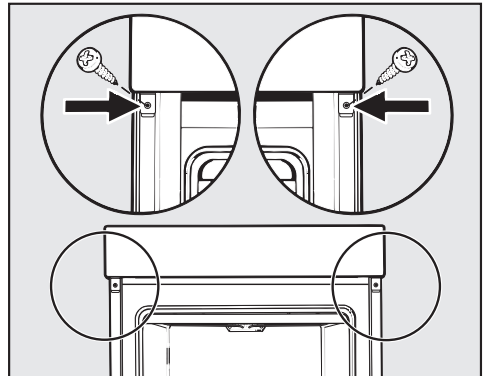

- Use the supplied screws to secure the oven to the side walls of the cabinetry through the holes in the trim.
- Reinstall the door, if necessary (see “Cleaning and care - Installing the door”).

Please have the model and serial number
of your appliance available when
contacting Technical Service.

The Miele logo consists of the word "Miele" in a bold, white, serif font, set against a solid black rectangular background.

U.S.A.

Miele, Inc.

National Headquarters

9 Independence Way
Princeton, NJ 08540
Phone: 800-843-7231
Fax: 609-419-4298
www.mieleusa.com

Technical Service & Support

Phone: 800-999-1360
Fax: 888-586-8056
TechnicalService@mieleusa.com

International Headquarters

Miele & Cie. KG
Carl-Miele-Straße 29
33332 Gütersloh
Germany

Canada

Importer
Miele Limited

Headquarters and Miele Centre

161 Four Valley Drive
Vaughan, ON L4K 4V8
www.miele.ca

Customer Care Centre

Phone: 800-565-6435
905-532-2272
customercare@miele.ca

H6560B

en-US, CA

M.-Nr. 09 786 780 / 05